

INDEX

INDEX / INDICE

PreSafe

H Type Scaffolding Systems 3

Systèmes d'Échafaudages Cadre pour Façade / Sistemas de Andamios de Marco

PreMulti

Multidirectional Scaffolding Systems 18

Systèmes d'Échafaudages Multidirectionnels / Sistemas de Andamios Multidireccionales

PreMobile

Mobile Scaffolding Systems..... 32

Systèmes d'Échafaudages Mobiles / Sistemas de Andamios Móviles

PreGuard

Edge Protection Systems..... 45

Barrières de Protection Anti-chute / Protección de Bordas

PreCont

Modular Systems 52

Systèmes Modulaires / Sistemas Modulares



ABOUT US

PRESOL is the leading company of all types of scaffoldings, edge protection systems and containers from Turkey.

With its professional team and effective customer service on 2 production facilities, **PRESOL** is proud to be the distinguished company of all types of scaffoldings in compliance with TS EN 12810 - 12811 certifications, TS EN - 13374 certified edge protection systems and containers that meet the requirements of European standards.

Exporting its certified products to many countries in different continents of the world, **PRESOL** has proven itself to be a reliable partner for international wholesalers, distributors and construction companies by giving priority to quality, both in its product ranges and after-sales services.

Besides the standardized product range, **PRESOL** project department is also capable of designing and implementing every type of scaffolding and container solutions depending on the esteemed customers' requirements.

PRESOL's principle is always to provide the optimal price / quality relation and the quickest delivery time possible to its distinguished customers.

À PROPOS DE NOUS

PRESOL est la société leader en Turquie pour tous les types d'échafaudages, de systèmes de barrière de protection et de conteneurs.

Grâce à son équipe professionnelle et à son service clientèle efficace sur 2 sites de production, **PRESOL** est fier d'être la société distinguée de tous les types d'échafaudages conformes aux certifications TS EN 12810 - 12811, aux systèmes de barrières de protection certifiés TS EN - 13374 et aux conteneurs répondant aux exigences des normes Européennes.

En exportant ses produits certifiés dans de nombreux pays des différents continents, **PRESOL** s'est révélé un partenaire fiable pour les grossistes, les distributeurs et les entreprises de construction du monde entier en privilégiant la qualité, tant dans ses gammes de produits que dans ses services après-vente.

En plus de la gamme de produits standardisée, le département projet de **PRESOL** est également capable de concevoir et de mettre en œuvre tous les types d'échafaudages et de conteneurs en fonction des besoins de nos clients.

Le principe de **PRESOL** est toujours de fournir le meilleur rapport qualité / prix possible ainsi que le délai de livraison le plus court possible à ses clients distingués.

QUIÉNES SOMOS

PRESOL es la empresa líder de todo tipo de andamios, sistemas de protección de bordes y contenedores de Turquía.

Con su equipo profesional y un servicio al cliente efectivo en 2 plantas distintas de producción, **PRESOL** se enorgullece de ser la compañía distinguida de todo tipo de andamios en cumplimiento con las certificaciones TS EN 12810 - 12811 y sistemas de protección de bordes certificados por TS EN - 13374 y contenedores que cumplen con los requisitos de las normas Europeas.

Al exportar sus productos certificados a una gran cantidad de países en diferentes continentes del mundo, **PRESOL** ha demostrado ser un socio confiable para mayoristas internacionales, distribuidores y empresas de construcción por prestar prioridad en la calidad, tanto en su gama de productos como en servicios postventa.

Además de la gama de productos estandarizados, el departamento de proyectos de **PRESOL** también es capaz de diseñar e implementar todo tipo de andamios, protección de bordes y soluciones de contenedores, según los requisitos de los estimados clientes.

El principio de **PRESOL** es proporcionar siempre la relación óptima de precio / calidad y el tiempo de entrega más rápido como sea posible a sus distinguidos clientes.

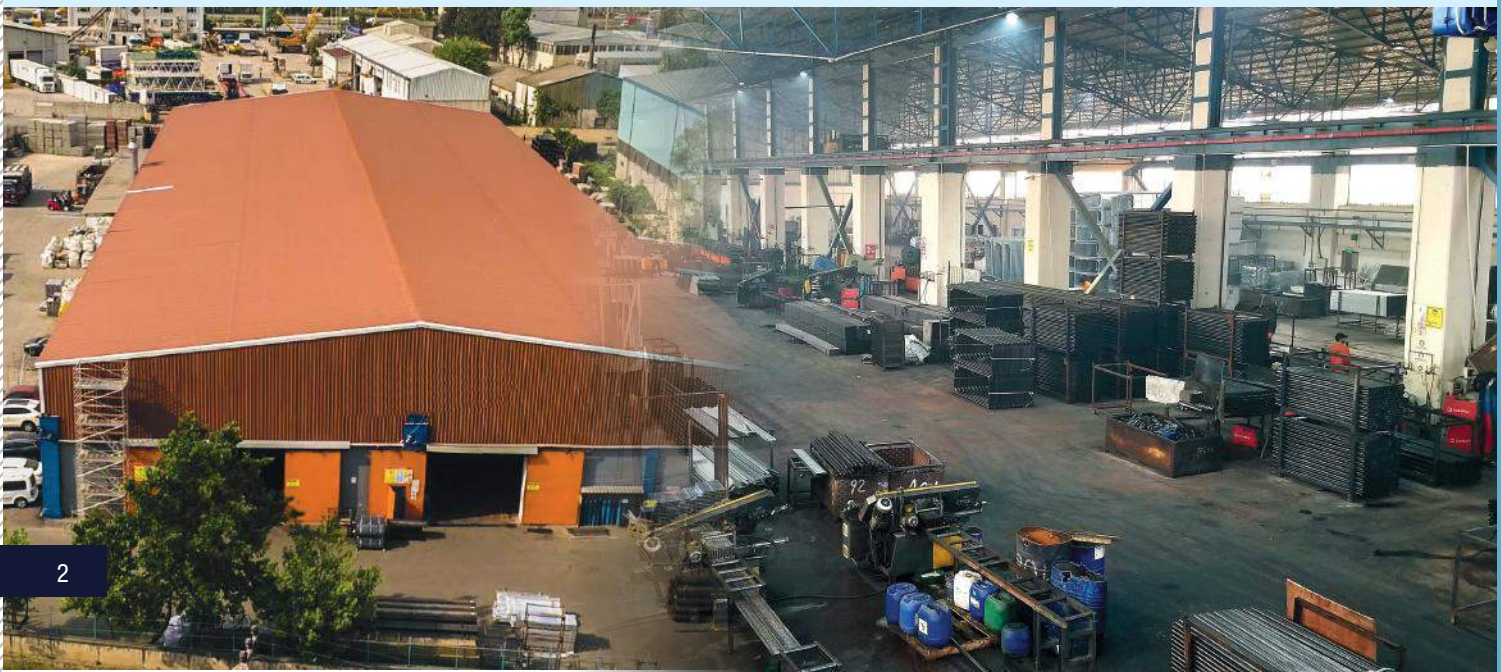

PreSafe

H Type Scaffolding Systems

Échafaudage Cadre pour Façade / Andamios de Marco

- 1- Main Frame / Cadre Principal / Marco Principal
- 2- Horizontal Brace / Barre Horizontale / Barra Horizontal
- 3- Diagonal Brace / Diagonale / Diagonal
- 4- Steel Deck / Plate-forme en Acier / Plataforma de Acero
- 5- Steel Deck with Ladder / Plate-forme en Acier avec Échelle / Plataforma de Acero con Escalera
- 6- Base Adjustment / Pied Réglable / Base Regulable
- 7- Starting Member / Pied de Départ / Pie de Arranque
- 8- End Guardrail / Garde-corps Latéral / Barandilla Lateral
- 9- Steel Toeboard / Plinthe en Acier / Rodapiés de Acero
- 10- Steel End Toeboard / Plinthe Latérale en Acier / Rodapiés Lateral de Acero

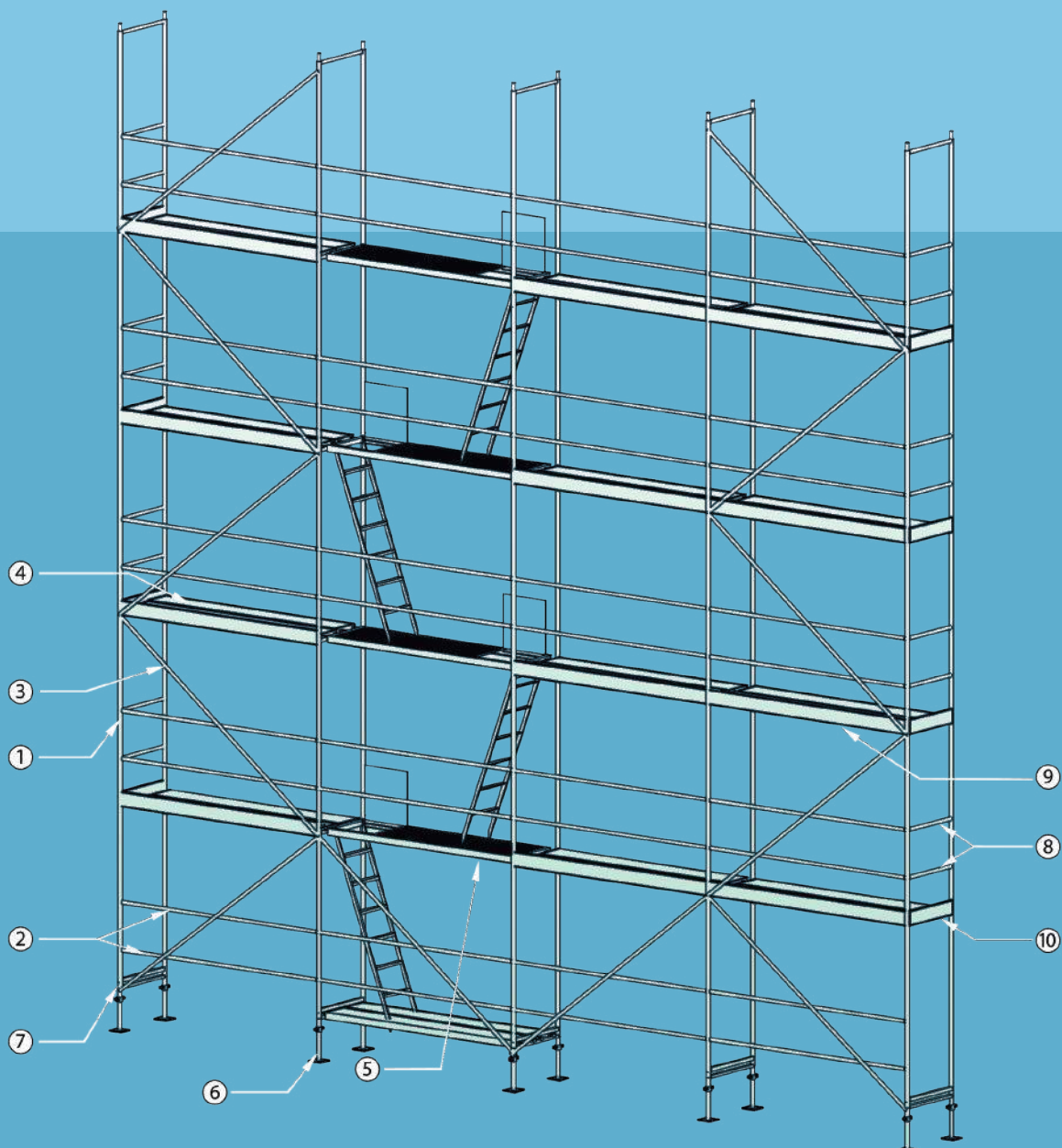

Main Frame / Cadre Principal / Marco Principal

Ø48x3 mm steel pipe, hot-dip galvanized

Tube d'acier Ø48x3 mm, galvanisé à chaud par immersion

Tubo de acero Ø48x3 mm, galvanizado por inmersión en caliente

Code Code Código	Dimensions Dimensions Dimensiones	Weight Poids Peso	Price Prix Precio
PS-MF075	75x200 cm	17.3 kg	50,00 €



Half Frame / Demi-Cadre / Medio Marco

Ø48x3 mm steel pipe, hot-dip galvanized

Tube d'acier Ø48x3 mm, galvanisé à chaud par immersion

Tubo de acero Ø48x3 mm, galvanizado por inmersión en caliente

Code Code Código	Dimensions Dimensions Dimensiones	Weight Poids Peso	Price Prix Precio
PS-HF075	75x100 cm	10.5 kg	37,00 €
PS-HF100	100x100 cm	12.7 kg	42,00 €



L Frame / Cadre en L / Marco de L

Ø48x3 mm steel pipe, hot-dip galvanized

Tube d'acier Ø48x3 mm, galvanisé à chaud par immersion

Tubo de acero Ø48x3 mm, galvanizado por inmersión en caliente

Code Code Código	Dimensions Dimensions Dimensiones	Weight Poids Peso	Price Prix Precio
PS-LF075	75x200 cm	9.0 kg	34,00 €
PS-LF100	100x200 cm	9.8 kg	36,00 €



Half L Frame / Demi-Cadre en L / Medio Marco de L
 Ø48x3 mm steel pipe, hot-dip galvanized
 Tube d'acier Ø48x3 mm, galvanisé à chaud par immersion
 Tubo de acero Ø48x3 mm, galvanizado por inmersión en caliente

Code Code Código	Dimensions Dimensions Dimensiones	Weight Poids Peso	Price Prix Precio
PS-HLF075	75x110 cm	6.0 kg	25,00 €
PS-HLF100	100x110 cm	6.8 kg	27,00 €



Asymmetric Frame / Cadre Asymétrique / Marco Asimétrico
 Ø48x3 mm steel pipe, hot-dip galvanized
 Tube d'acier Ø48x3 mm, galvanisé à chaud par immersion
 Tubo de acero Ø48x3 mm, galvanizado por inmersión en caliente

Code Code Código	Dimensions Dimensions Dimensiones	Weight Poids Peso	Price Prix Precio
PS-AF075	75x200 cm	13.0 kg	45,00 €
PS-AF100	100x200 cm	15.2 kg	50,00 €



Large Main Frame / Cadre Large Principal / Marco Principal Grande
 Ø48x3 mm steel pipe, hot-dip galvanized
 Tube d'acier Ø48x3 mm, galvanisé à chaud par immersion
 Tubo de acero Ø48x3 mm, galvanizado por inmersión en caliente

Code Code Código	Dimensions Dimensions Dimensiones	Weight Poids Peso	Price Prix Precio
PS-AF200	100x200 cm	19.5 kg	55,00 €



Horizontal Brace / Barre Horizontale / Barra Horizontal

Ø34x2 mm steel pipe, hot-dip galvanized

Tube d'acier Ø34x2 mm, galvanisé à chaud par immersion

Tubo de acero Ø34x2 mm, galvanizado por inmersión en caliente

Code Code Código	Dimensions Dimensions Dimensiones	Weight Poids Peso	Price Prix Precio
PS-HB300	300 cm	4.8 kg	12,50 €
PS-HB250	250 cm	4.0 kg	11,00 €
PS-HB200	200 cm	3.2 kg	9,50 €
PS-HB150	150 cm	2.4 kg	8,00 €
PS-HB100	100 cm	1.6 kg	6,50 €



Adjustable Horizontal Brace / Barre Horizontale Réglable / Barra Horizontal Regulable

Ø34x2 mm - Ø42x2.5 mm steel pipe, hot-dip galvanized

Tube d'acier Ø34x2 mm - Ø42x2.5, galvanisé à chaud par immersion

Tubo de acero Ø34x2 mm - Ø42x2.5, galvanizado por inmersión en caliente

Code Code Código	Dimensions Dimensions Dimensiones	Weight Poids Peso	Price Prix Precio
PS-AHB-250	140-250 cm	6.0 kg	18,00 €
PS-AHB-140	85-140 cm	3.0 kg	12,00 €



Diagonal Brace / Diagonale / Diagonal

Ø42x2.5 mm steel pipe, hot-dip galvanized

Tube d'acier Ø42x2.5 mm, galvanisé à chaud par immersion

Tubo de acero Ø42x2.5 mm, galvanizado por inmersión en caliente

Code Code Código	Dimensions Dimensions Dimensiones	Weight Poids Peso	Price Prix Precio
PS-DB364	364 cm	8.7 kg	24,00 €
PS-DB324	324 cm	7.8 kg	22,00 €
PS-DB286	286 cm	6.8 kg	20,00 €
PS-DB254	254 cm	6.0 kg	18,00 €
PS-DB227	227 cm	5.4 kg	16,00 €



Steel Deck / Plate-forme en Acier / Plataforma de Acero

1.5 mm thickness, galvanized

Épaisseur de 1.5 mm, galvanisé

Espesor de 1.5 mm, galvanizado

Code Code Código	Dimensions Dimensions Dimensiones	Weight Poids Peso	Price Prix Precio
PS-SD-G300	30x300 cm	17.5 kg	45,00 €
PS-SD-G250	30x250 cm	15.0 kg	40,00 €
PS-SD-G200	30x200 cm	12.5 kg	35,00 €
PS-SD-G150	30x150 cm	9.8 kg	30,00 €
PS-SD-G100	30x100 cm	7.0 kg	25,00 €
PS-SD-G075	30x75 cm	6.0 kg	22,00 €

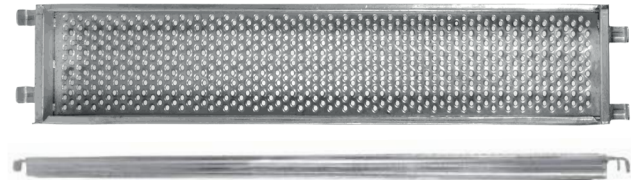
**Steel Deck** / Plate-forme en Acier / Plataforma de Acero

1.5 mm thickness, hot-dip galvanized

Épaisseur de 1.5 mm, galvanisé à chaud par immersion

Espesor de 1.5 mm, galvanizado por inmersión en caliente

Code Code Código	Dimensions Dimensions Dimensiones	Weight Poids Peso	Price Prix Precio
PS-SD-HD300	30x300 cm	18.0 kg	63,00 €
PS-SD-HD250	30x250 cm	15.5 kg	55,00 €
PS-SD-HD200	30x200 cm	13.0 kg	47,00 €
PS-SD-HD150	30x150 cm	10.0 kg	39,00 €
PS-SD-HD100	30x100 cm	7.5 kg	31,00 €
PS-SD-HD075	30x75 cm	6.3 kg	27,00 €

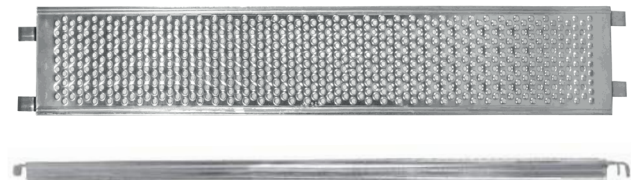
**Steel Deck with Ladder** / Plate-forme en Acier avec Échelle / Plataforma de Acero con Escalera

1.5 mm thickness, hot-dip galvanized

Épaisseur de 1.5 mm, galvanisé à chaud par immersion

Espesor de 1.5 mm, galvanizado por inmersión en caliente

Code Code Código	Dimensions Dimensions Dimensiones	Weight Poids Peso	Price Prix Precio
PS-SD-L300	60x300 cm	40.0 kg	160,00 €
PS-SD-L250	60x250 cm	35.0 kg	140,00 €
PS-SD-L200	60x200 cm	30.0 kg	120,00 €
PS-SD-L150	60x150 cm	25.0 kg	100,00 €
PS-SL215	34x215 cm	9.0 kg	35,00 €

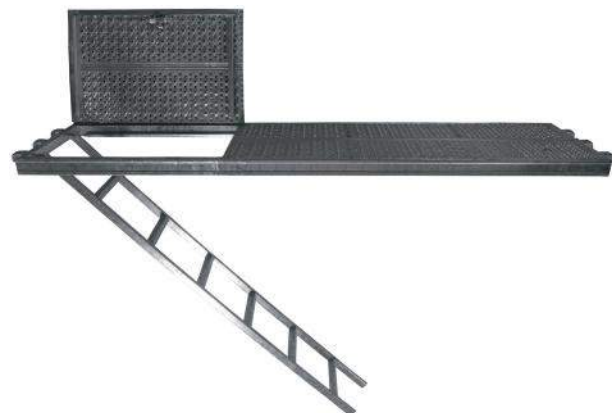

Aluminium Deck / Plate-forme en Aluminium / Plataforma de Aluminio

Aluminium profile, anti-slip plywood of 9 mm thickness

Profilé d'aluminium, contreplaqué antidérapant de 9 mm d'épaisseur

Perfil de aluminio, madera contrachapada antideslizante de 9 mm de espesor

Code Code Código	Dimensions Dimensions Dimensiones	Weight Poids Peso	Price Prix Precio
PS-ALD300	63x300 cm	21.5 kg	185,00 €
PS-ALD250	63x250 cm	17.5 kg	160,00 €
PS-ALD200	63x200 cm	14.5 kg	150,00 €
PS-ALD150	63x150 cm	11.5 kg	115,00 €
PS-ALD105	63x105 cm	9.0 kg	95,00 €
PS-ALD075	63x75 cm	7.5 kg	85,00 €



Aluminium Deck with Ladder / Plate-forme en Aluminium avec Échelle / Plataforma de Aluminio con Escalera

Aluminium profile, anti-slip plywood of 9 mm thickness, aluminium stair

Profilé d'aluminium, contreplaqué antidérapant de 9 mm d'épaisseur, échelle en aluminium

Perfil de aluminio, madera contrachapada antideslizante de 9 mm de espesor, escalera de aluminio

Code Code Código	Dimensions Dimensions Dimensiones	Weight Poids Peso	Price Prix Precio
PS-ALD-L300	63x300 cm	22.5 kg	215,00 €
PS-ALD-L250	63x250 cm	18.5 kg	190,00 €
PS-ALD-L200	63x200 cm	15.5 kg	180,00 €
PS-ALD-L150	63x150 cm	12.5 kg	145,00 €
PS-AL215	36x215 cm	4.0 kg	40,00 €

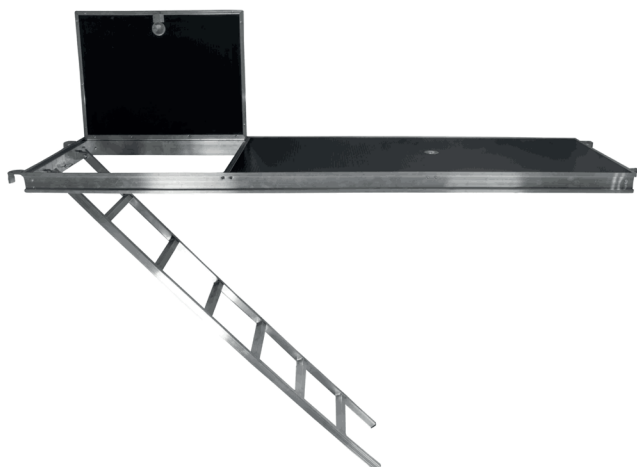

Steel Z Ladder / Escalier Z en Acier / Escalera Z de Acero

Code Code Código	Dimensions Dimensions Dimensiones	Weight Poids Peso	Price Prix Precio
PS-SLZ-365-90	90x365 cm	77.0 kg	290,00 €
PS-SLZ-325-90	90x325 cm	70.0 kg	260,00 €
PS-SLZ-365-60	60x365 cm	65.0 kg	230,00 €
PS-SLZ-325-60	60x325 cm	58.0 kg	210,00 €

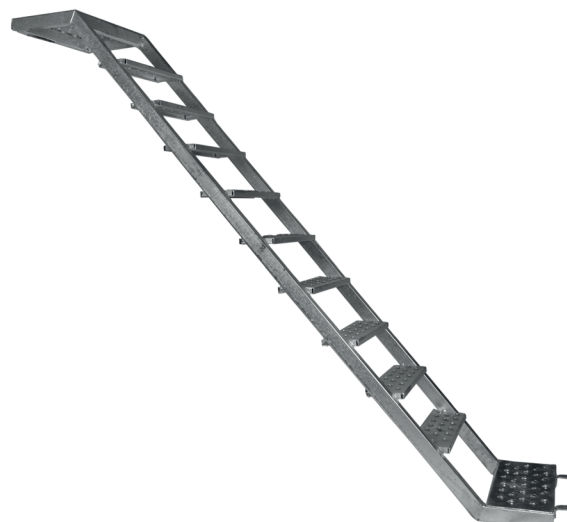

Aluminium Z Ladder / Escalier Z en Aluminium / Escalera Z de Aluminio

Code Code Código	Dimensions Dimensions Dimensiones	Weight Poids Peso	Price Prix Precio
PS-ALZ-365-90	90x365 cm	42.0 kg	600,00 €
PS-ALZ-325-90	90x325 cm	37.0 kg	550,00 €
PS-ALZ-365-60	60x365 cm	28.0 kg	375,00 €
PS-ALZ-325-60	60x325 cm	24.0 kg	350,00 €



Steel Z Ladder Guardrail / Garde-corps en Acier pour Escalier Z / Barandilla de Acero para Escalera Z

Code Code Código	Dimensions Dimensions Dimensiones	Weight Poids Peso	Price Prix Precio
PS-SGR-EXT300	100x300 cm	21.0 kg	90,00 €
PS-SGR-EXT250	100x250 cm	18.0 kg	85,00 €
PS-SGR-INT200	100x200 cm	10.0 kg	54,00 €

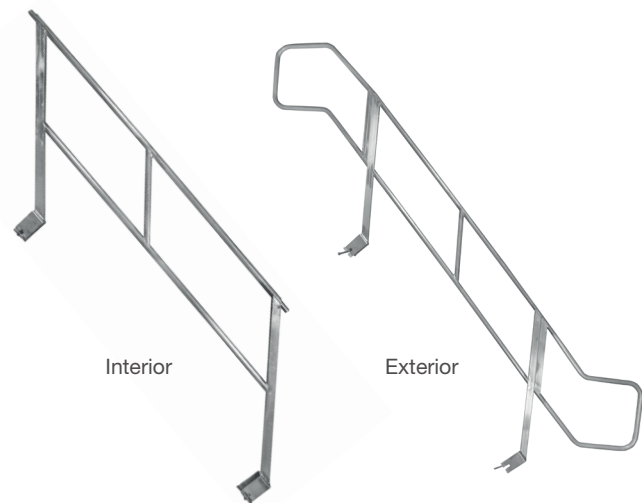

Aluminium Z Ladder Guardrail / Garde-corps en Aluminium pour Escalier Z / Barandilla de Aluminio para Escalera Z

Code Code Código	Dimensions Dimensions Dimensiones	Weight Poids Peso	Price Prix Precio
PS-AGR-EXT300	100x300 cm	10.0 kg	160,00 €
PS-AGR-EXT250	100x250 cm	9.0 kg	143,00 €
PS-AGR-INT200	100x200 cm	7.0 kg	88,00 €

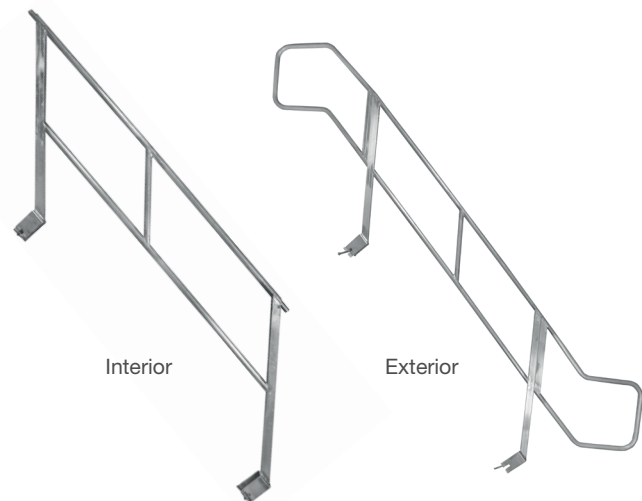

Steel Toeboard / Plinthe en Acier / Rodapiés de Acero

1 mm thickness, galvanized

1 mm d'épaisseur, galvanisé

1 mm de espesor, galvanizado

Code Code Código	Dimensions Dimensions Dimensiones	Weight Poids Peso	Price Prix Precio
PS-ST300	15x300 cm	6.0 kg	18,00 €
PS-ST250	15x250 cm	5.0 kg	16,00 €
PS-ST200	15x200 cm	4.0 kg	14,00 €
PS-ST150	15x150 cm	3.0 kg	12,00 €
PS-ST100	15x100 cm	2.0 kg	10,00 €



Steel End Toeboard / Plinthe Latérale en Acier / Rodapiés Lateral de Acero

1 mm thickness, galvanized

1 mm d'épaisseur, galvanisé

1 mm de espesor, galvanizado

Code Code Código	Dimensions Dimensions Dimensiones	Weight Poids Peso	Price Prix Precio
PS-SET095	15x90 cm	2.0 kg	13,00 €
PS-SET065	15x65 cm	1.5 kg	9,00 €



Base Adjustment / Pied Réglable / Base Regulable

Ø38x4 mm steel pipe, 150x150x5 mm base plate

Tube d'acier Ø38x4 mm, plaque de base galvanisé de 150x150x5 mm

Tube de acero Ø38x4 mm, placa de base galvanizada de 150x150x5 mm

Code Code Código	Dimensions Dimensions Dimensiones	Weight Poids Peso	Price Prix Precio
PS-BA100	100 cm	4.1 kg	15,00 €
PS-BA070	70 cm	3.3 kg	13,50 €
PS-BA050	50 cm	2.8 kg	12,00 €



Articulated Base Adjustment / Pied Réglable Articulé / Base Regulable Articulada

Ø38x4 mm steel pipe, 150x150x5 mm base plate, galvanized

Tube d'acier Ø38x4 mm, plaque de base galvanisé de 150x150x5 mm

Tubo de acero Ø38x4 mm, placa de base galvanizada de 150x150x5 mm

Code Code Código	Dimensions Dimensions Dimensiones	Weight Poids Peso	Price Prix Precio
PS-ABA100	100 cm	4.6 kg	18,00 €
PS-ABA070	70 cm	3.8 kg	16,50 €
PS-ABA050	50 cm	3.3 kg	15,00 €

**End Guardrail** / Garde-corps Latéral / Barandilla Lateral

Galvanized

Galvanisé

Galvanizado

Code Code Código	Dimensions Dimensions Dimensiones	Weight Poids Peso	Price Prix Precio
PS-EG090	90 cm	2.0 kg	8,00 €
PS-EG065	65 cm	1.4 kg	6,50 €

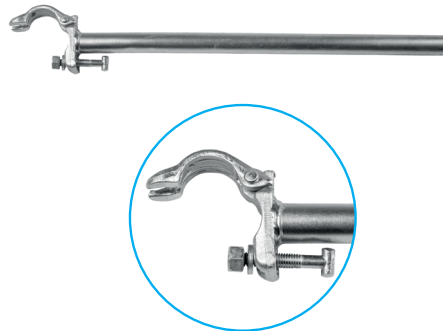
**Starting Member** / Pied de Départ / Pie de Arranque

Hot-dip galvanized

Galvanisé à chaud par immersion

Galvanizado por inmersión en caliente

Code Code Código	Dimensions Dimensions Dimensiones	Weight Poids Peso	Price Prix Precio
PS-SM100	100 cm	3.0 kg	12,00 €
PS-SM075	75 cm	2.3 kg	10,00 €



WALL CONNECTION KIT

Kit d'Amarrage Mural / Kit de Amarre Mural

Wall Connection Pipe / Tube d'Amarrage / Tubo de Amarre

Ø48x3.2 mm steel pipe, hot-dip galvanized

Tube d'acier Ø48x3.2 mm, galvanisé à chaud par immersion

Tubo de acero Ø48x3.2 mm, galvanizado por inmersión en caliente

Code Code Código	Dimensions Dimensions Dimensiones	Weight Poids Peso	Price Prix Precio
PS-CP100	100 cm	3.7 kg	12,00 €
PS-CP090	90 cm	3.3 kg	11,00 €
PS-CP080	80 cm	3.0 kg	10,00 €
PS-CP070	70 cm	2.7 kg	9,00 €
PS-CP060	60 cm	2.3 kg	8,00 €
PS-CP050	50 cm	1.9 kg	7,00 €
PS-CP040	40 cm	1.6 kg	6,00 €



Fixed Coupler / Collier Fixe / Abrazadera Fija

EN 74-1, forged, galvanized / EN 74-1, forgé, galvanisé / EN 74-1, forjado, galvanizado

Code Code Código	Dimensions Dimensions Dimensiones	Weight Poids Peso	Price Prix Precio
PS-FC	Ø48x48	1.0 kg	5,00 €



Wall Fixing Peg / Cheville / Perno

Code Code Código	Dimensions Dimensions Dimensiones	Weight Poids Peso	Price Prix Precio
PS-FP	M12	0.1 kg	0,50 €



Wall Fixing Bolt / Piton d'Amarrage / Pitón de Acero

Code Code Código	Dimensions Dimensions Dimensiones	Weight Poids Peso	Price Prix Precio
PS-FB	21,5 cm	0.2 kg	2,00 €



Swivel Coupler / Collier Orientable / Abrazadera Giratoria

EN 74-1, forged, galvanized / EN 74-1, forgé, galvanisé / EN 74-1, forjado, galvanizado

Code Code Código	Dimensions Dimensions Dimensiones	Weight Poids Peso	Price Prix Precio
PS-SC	Ø48x48	1.1 kg	5,50 €

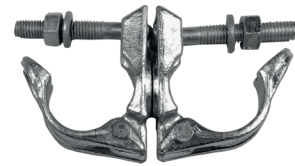
**Putlog Coupler** / Collier Putlog / Abrazadera Putlog

Forged, galvanized / Forgé, galvanisé / Forjado, galvanizado

Code Code Código	Dimensions Dimensions Dimensiones	Weight Poids Peso	Price Prix Precio
PS-PGC	Ø48	0.7 kg	4,00 €

**Pin Clamp** / Collier à Clavette / Abrazadera con Cuña

Forged, galvanized / Forgé, galvanisé / Forjado, galvanizado

Code Code Código	Dimensions Dimensions Dimensiones	Weight Poids Peso	Price Prix Precio
PS-PC	Ø48	0.7 kg	4,50 €

**Toeboard Clamp** / Collier de Plinthe / Abrazadera para Rodapiés

Forged, galvanized / Forgé, galvanisé / Forjado, galvanizado

Code Code Código	Dimensions Dimensions Dimensiones	Weight Poids Peso	Price Prix Precio
PS-TC	Ø48	0.9 kg	5,00 €



Girder Coupler / Collier de Poutre / Abrazadera para Viga

Forged, galvanized / Forgé, galvanisé / Forjado, galvanizado

Code Code Código	Dimensions Dimensions Dimensiones	Weight Poids Peso	Price Prix Precio
PS-GC	Ø48	1.4 kg	9,00 €



Sleeve Coupler / Manchon Tuyau Collier Double / Doble Abrazadera de Manga

Forged, galvanized / Forgé, galvanisé / Forjado, galvanizado

Code Code Código	Dimensions Dimensions Dimensiones	Weight Poids Peso	Price Prix Precio
PS-SVC	Ø48x48	1.0 kg	5,00 €



Spigot Adapter Clamp / Collier Adaptateur Spigot / Abrazadera Adaptadora de Espiga

Code Code Código	Dimensions Dimensions Dimensiones	Weight Poids Peso	Price Prix Precio
PS-SAC	Ø48	1.2 kg	5,50 €



Base Adjustment Adapter Clamp / Manchon Réglable à Collier / Abrazadera Adaptadora de Base Regulable

Code Code Código	Dimensions Dimensions Dimensiones	Weight Poids Peso	Price Prix Precio
PS-BAC	50 cm	2.4 kg	15,00 €



Horizontal Brace with Couplers / Barre Horizontale à Colliers / Barra Horizontal con Abrazaderas

Code Code Código	Dimensions Dimensions Dimensiones	Weight Poids Peso	Price Prix Precio
PS-HBC100	100 cm	4.1 kg	15,50 €
PS-HBC075	75 cm	3.2 kg	13,00 €



Galvanized Pipe / Tube Galvanisé / Tubo Galvanizado

Ø48x3 mm steel pipe, hot-dip galvanized

Tube d'acier Ø48x3 mm, galvanisé à chaud par immersion

Tubo de acero Ø48x3 mm, galvanizado por inmersión en caliente

Code Code Código	Dimensions Dimensions Dimensiones	Weight Poids Peso	Price Prix Precio
PS-GP600	600 cm	21.0 kg	48,00 €
PS-GP300	300 cm	10.5 kg	24,00 €
PS-GP200	200 cm	7.0 kg	16,00 €
PS-GP100	100 cm	3.5 kg	8,00 €



Frame Adapter / Adaptateur de Cadre / Adaptador de Marco

Code Code Código	Dimensions Dimensions Dimensiones	Weight Poids Peso	Price Prix Precio
PS-FA	50x100 cm	11.5 kg	50,00 €



Steel Lattice Beam / Cadres de Liaison en Acier / Viga Enrejada de Acero

Ø48x3 mm steel pipe, hot-dip galvanized

Tube d'acier Ø48x3 mm, galvanisé à chaud par immersion

Tubo de acero Ø48x3 mm, galvanizado por inmersión en caliente

Code Code Código	Dimensions Dimensions Dimensiones	Weight Poids Peso	Price Prix Precio
PS-SLB820	45x820 cm	75.0 kg	250,00 €
PS-SLB720	45x720 cm	66.0 kg	225,00 €
PS-SLB620	45x620 cm	57.0 kg	200,00 €
PS-SLB520	45x520 cm	48.5 kg	175,00 €
PS-SLB420	45x420 cm	40.0 kg	150,00 €
PS-SLB320	45x320 cm	32.0 kg	125,00 €

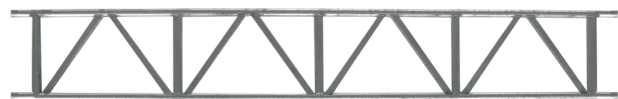

Aluminium Lattice Beam / Cadres de Liaison en Aluminium / Viga Enrejada en Aluminio

Ø48x4 mm aluminium pipe

Tube d'aluminium Ø48x4 mm

Tubo de aluminio Ø48x4 mm

Code Code Código	Dimensions Dimensions Dimensiones	Weight Poids Peso	Price Prix Precio
PS-ALB820	45x820 cm	34.0 kg	450,00 €
PS-ALB720	45x720 cm	30.0 kg	400,00 €
PS-ALB620	45x620 cm	26.0 kg	350,00 €
PS-ALB520	45x520 cm	22.0 kg	300,00 €
PS-ALB420	45x420 cm	19.0 kg	250,00 €
PS-ALB320	45x320 cm	15.5 kg	200,00 €



Console / Console / Consola

Ø48x3 mm steel pipe, 40x40x2 mm profile, galvanized

Tube d'acier Ø48x3 mm, profilé de 40x40x2 mm, galvanisé

Tubo de acero Ø48x3 mm, perfil de 40x40x2 mm, galvanizado

Code Code Código	Dimensions Dimensions Dimensiones	Weight Poids Peso	Price Prix Precio
PS-CON105	105 cm	11.0 kg	37,50 €
PS-CON075	75 cm	7.3 kg	30,00 €
PS-CON045	45 cm	5.9 kg	25,00 €



Container / Conteneur / Contenedor

1.5 mm thickness, electrostatic painted

Épaisseur de 1.5 mm, peint électrostatique

Espesor de 1.5 mm, pintura electrostática

Code Code Código	Dimensions Dimensions Dimensiones	Weight Poids Peso	Price Prix Precio
PS-CNT	80x130 cm	60.0 kg	250,00 €



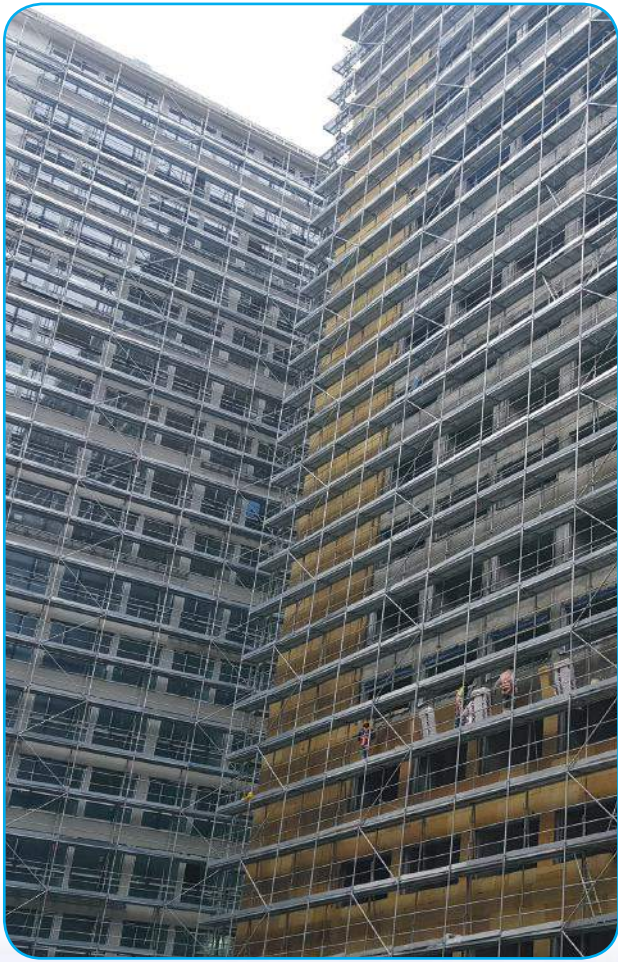

PreMulti

Multidirectional Scaffolding Systems

Échafaudage Multidirectionnel / Andamios Multidireccionales

- 1- Vertical Brace / Montant Vertical / Tubo Vertical
- 2- Horizontal Brace / Barre Horizontale / Barra Horizontal
- 3- Diagonal Brace / Diagonale / Diagonal
- 4- Steel Deck / Plate-forme en Acier / Plataforma de Acero
- 5- Deck with Ladder / Plate-forme en Acier avec Échelle / Plataforma de Acero con Escalera
- 6- Base Adjustment / Pied Réglable / Base Regulable
- 7- Starting Member / Pied de Départ / Pie de Arranque
- 8- End Guardrail / Garde-corps Latéral / Barandilla Lateral
- 9- Steel Toeboard / Plinthe en Acier / Rodapiés de Acero
- 10- Steel End Toeboard / Plinthe Latérale en Acier / Rodapiés Lateral de Acero

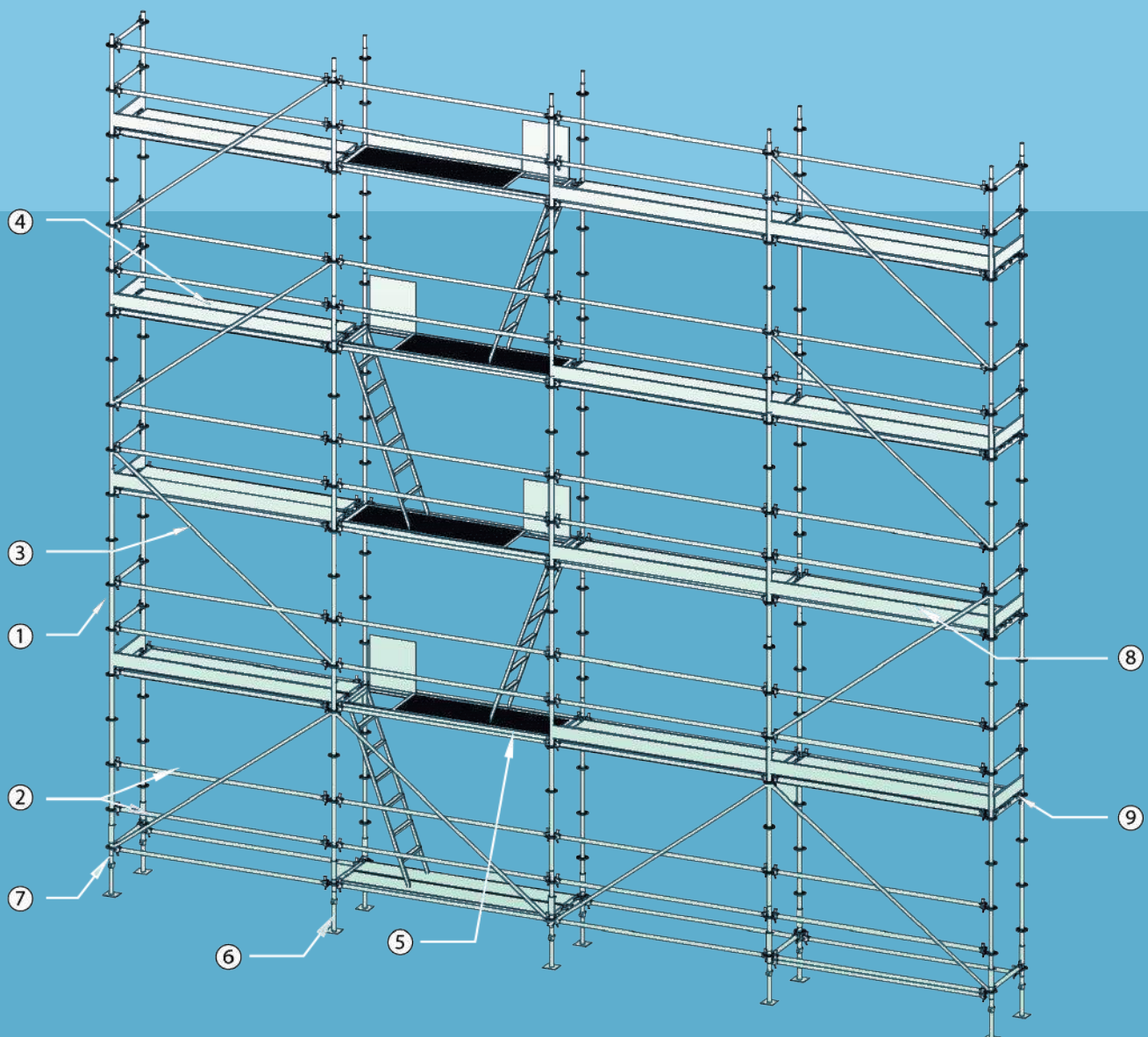

Vertical Brace / Montant Vertical / Tubo Vertical

Ø48x3 mm steel pipe, 8 mm flange, hot-dip galvanized

Tube d'acier Ø48x3 mm, rosette de 8 mm, galvanisé à chaud par immersion

Tubo de acero Ø48x3 mm, roseta de 8 mm, galvanizado por inmersión en caliente

Code Code Código	Dimensions Dimensions Dimensiones	Weight Poids Peso	Price Prix Precio
PM-VB300	300 cm	13.2 kg	50,00 €
PM-VB250	250 cm	11.0 kg	42,50 €
PM-VB200	200 cm	8.9 kg	35,00 €
PM-VB150	150 cm	6.8 kg	27,50 €
PM-VB100	100 cm	4.7 kg	20,00 €
PM-VB050	50 cm	2.6 kg	13,40 €

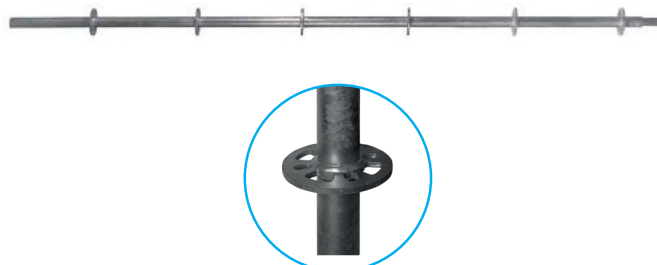
**Horizontal Brace** / Barre Horizontale / Barra Horizontal

Ø48x2.5 mm steel pipe, forged brace head hot-dip galvanized

Tube d'acier Ø48x2.5 mm, forgé galvanisé à chaud par immersion

Tubo de acero Ø48x2.5 mm, empalme forjado, galvanizado por inmersión en caliente

Code Code Código	Dimensions Dimensions Dimensiones	Weight Poids Peso	Price Prix Precio
PM-HB300	300 cm	9.0 kg	31,70 €
PM-HB250	250 cm	7.6 kg	28,40 €
PM-HB200	200 cm	6.2 kg	25,00 €
PM-HB150	150 cm	4.7 kg	21,70 €
PM-HB110	110 cm	3.6 kg	18,00 €
PM-HB075	75 cm	2.8 kg	15,00 €

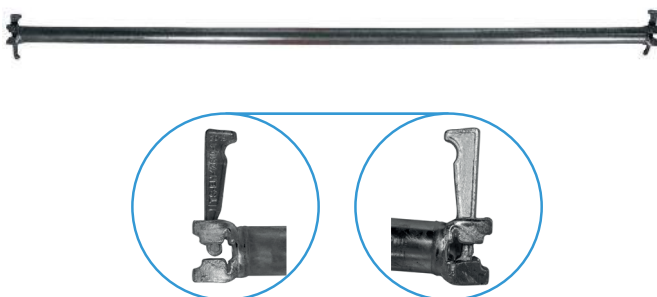
**Diagonal Brace** / Diagonale / Diagonal

Ø48x2.5 mm steel pipe, forged brace head hot-dip galvanized

Tube d'acier Ø48x2.5 mm, forgé galvanisé à chaud par immersion

Tubo de acero Ø48x2.5 mm, empalme forjado, galvanizado por inmersión en caliente

Code Code Código	Dimensions Dimensions Dimensiones	Weight Poids Peso	Price Prix Precio
PM-DB365	365 cm	9.6 kg	36,70 €
PM-DB324	324 cm	8.5 kg	33,00 €
PM-DB287	287 cm	7.6 kg	31,00 €
PM-DB249	249 cm	6.6 kg	28,80 €
PM-DB231	231 cm	6.1 kg	27,00 €
PM-DB219	219 cm	5.8 kg	25,80 €



Steel Deck / Plate-forme en Acier / Plataforma de Acero

1.5 mm thickness, galvanized

Épaisseur de 1.5 mm, galvanisé

Espesor de 1.5 mm, galvanizado

Code Code Código	Dimensions Dimensions Dimensiones	Weight Poids Peso	Price Prix Precio
PM-SD300	30x300 cm	18.0 kg	48,00 €
PM-SD250	30x250 cm	15.5 kg	43,00 €
PM-SD200	30x200 cm	13.0 kg	38,00 €
PM-SD140	30x140 cm	9.5 kg	33,00 €
PM-SD105	30x105 cm	8.0 kg	28,00 €
PM-SD075	30x75 cm	6.5 kg	25,00 €



Steel Deck / Plate-forme en Acier / Plataforma de Acero

1.5 mm thickness, hot-dip galvanized

Épaisseur de 1.5 mm, galvanisé à chaud par immersion

Espesor de 1.5 mm, galvanizado por inmersión en caliente

Code Code Código	Dimensions Dimensions Dimensiones	Weight Poids Peso	Price Prix Precio
PM-SD-HD300	30x300 cm	18.5 kg	65,00 €
PM-SD-HD250	30x250 cm	16.0 kg	57,00 €
PM-SD-HD200	30x200 cm	13.5 kg	49,00 €
PM-SD-HD140	30x140 cm	10.0 kg	41,00 €
PM-SD-HD105	30x105 cm	8.0 kg	34,00 €
PM-SD-HD075	30x75 cm	6.5 kg	29,00 €



Steel Deck with Ladder / Plate-forme en Acier avec Échelle / Plataforma de Acero con Escalera

1.5 mm thickness, hot-dip galvanized

Épaisseur de 1.5 mm, galvanisé à chaud par immersion

Espesor de 1.5 mm, galvanizado por inmersión en caliente

Code Code Código	Dimensions Dimensions Dimensiones	Weight Poids Peso	Price Prix Precio
PM-SD-L300	60x300 cm	40.5 kg	161,00 €
PM-SD-L250	60x250 cm	35.5 kg	141,00 €
PM-SD-L200	60x200 cm	30.5 kg	121,00 €
PM-SD-L140	60x140 cm	25.5 kg	101,00 €
PM-SL215	34x215 cm	9.0 kg	35,00 €

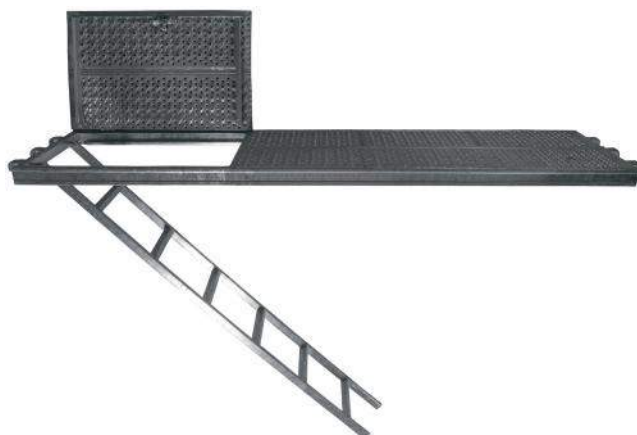

Aluminium Deck / Plate-forme en Aluminium / Plataforma de Aluminio

Aluminium profile, anti-slip plywood of 9 mm thickness

Profilé d'aluminium, contreplaqué antidérapant de 9 mm d'épaisseur

Perfil de aluminio, madera contrachapada antideslizante de 9 mm de espesor

Code Code Código	Dimensions Dimensions Dimensiones	Weight Poids Peso	Price Prix Precio
PM-ALD300	63x300 cm	21.5 kg	185,00 €
PM-ALD250	63x250 cm	17.5 kg	160,00 €
PM-ALD200	63x200 cm	14.5 kg	150,00 €
PM-ALD140	63x140 cm	11.0 kg	110,00 €
PM-ALD105	63x105 cm	9.0 kg	95,00 €
PM-ALD075	63x75 cm	7.5 kg	85,00 €

**Aluminium Deck with Ladder** / Plate-forme en Aluminium avec Échelle / Plataforma de Aluminio con Escalera

Aluminium profile, anti-slip plywood of 9 mm thickness, aluminium stair

Profilé d'aluminium, contreplaqué antidérapant de 9 mm d'épaisseur, échelle en aluminium

Perfil de aluminio, madera contrachapada antideslizante de 9 mm de espesor, escalera de aluminio

Code Code Código	Dimensions Dimensions Dimensiones	Weight Poids Peso	Price Prix Precio
PM-ALD-L300	63x300 cm	22.5 kg	215,00 €
PM-ALD-L250	63x250 cm	18.5 kg	190,00 €
PM-ALD-L200	63x200 cm	15.5 kg	180,00 €
PM-ALD-L140	63x140 cm	12.0 kg	140,00 €
PM-AL215	36x215 cm	4.0 kg	40,00 €

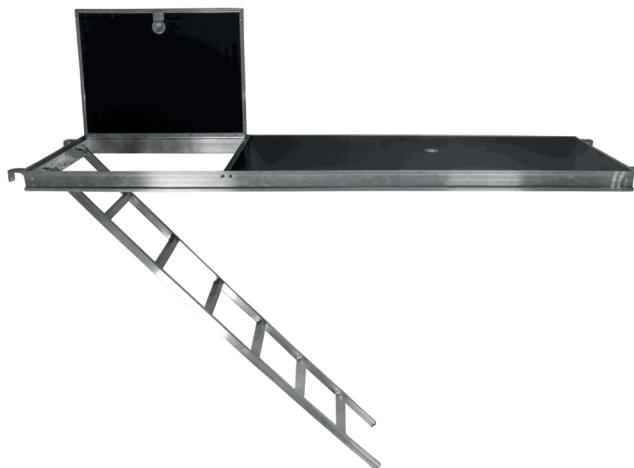
**Steel Z Ladder** / Escalier Z en Acier / Escalera Z de Acero

Code Code Código	Dimensions Dimensions Dimensiones	Weight Poids Peso	Price Prix Precio
PM-SLZ-365-90	90x365 cm	77.0 kg	290,00 €
PM-SLZ-325-90	90x325 cm	70.0 kg	260,00 €
PM-SLZ-365-60	60x365 cm	65.0 kg	230,00 €
PM-SLZ-325-60	60x325 cm	58.0 kg	210,00 €



Aluminium Z Ladder / Escalier Z en Aluminium / Escalera Z de Aluminio

Code Code Código	Dimensions Dimensions Dimensiones	Weight Poids Peso	Price Prix Precio
PM-ALZ-365-90	90x365 cm	42.0 kg	600,00 €
PM-ALZ-325-90	90x325 cm	37.0 kg	550,00 €
PM-ALZ-365-60	60x365 cm	28.0 kg	375,00 €
PM-ALZ-325-60	60x325 cm	24.0 kg	350,00 €



Steel Z Ladder Guardrail / Garde-corps en Acier pour Escalier Z / Barandilla de Acero para Escalera Z

Code Code Código	Dimensions Dimensions Dimensiones	Weight Poids Peso	Price Prix Precio
PM-SGR-EXT300	100x300 cm	21.0 kg	90,00 €
PM-SGR-EXT250	100x250 cm	18.0 kg	85,00 €
PM-SGR-INT200	100x200 cm	10.0 kg	54,00 €

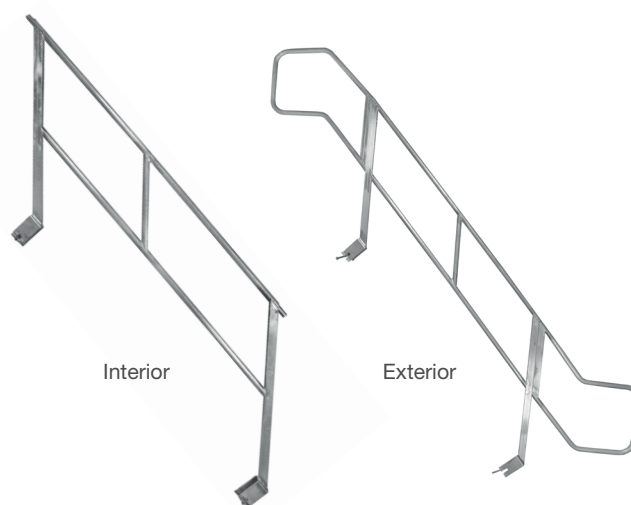

Aluminium Z Ladder Guardrail / Garde-corps en Aluminium pour Escalier Z / Barandilla de Aluminio para Escalera Z

Code Code Código	Dimensions Dimensions Dimensiones	Weight Poids Peso	Price Prix Precio
PM-AGR-EXT300	100x300 cm	10.0 kg	160,00 €
PM-AGR-EXT250	100x250 cm	9.0 kg	143,00 €
PM-AGR-INT200	100x200 cm	7.0 kg	88,00 €

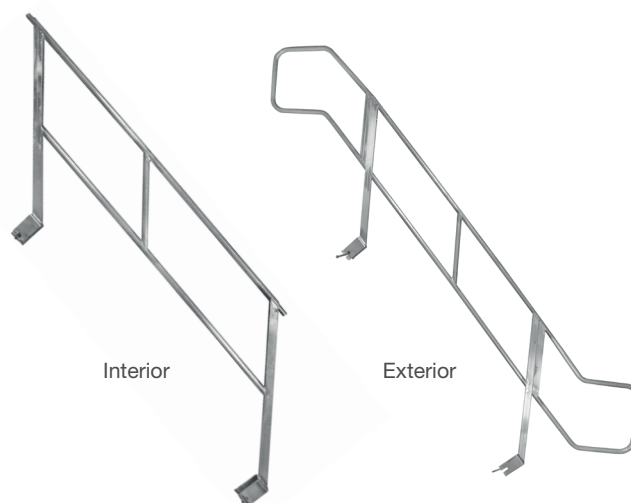

Steel Toeboard / Plinthe en Acier / Rodapiés de Acero

1 mm thickness, galvanized

1 mm d'épaisseur, galvanisé

1 mm de espesor, galvanizado

Code Code Código	Dimensions Dimensions Dimensiones	Weight Poids Peso	Price Prix Precio
PM-ST300	15x300 cm	6.5 kg	20,00 €
PM-ST250	15x250 cm	5.5 kg	18,00 €
PM-ST200	15x200 cm	4.5 kg	16,00 €
PM-ST140	15x140 cm	3.3 kg	14,00 €
PM-ST105	15x105 cm	2.7 kg	12,50 €
PM-ST075	15x75 cm	2.1 kg	11,50 €

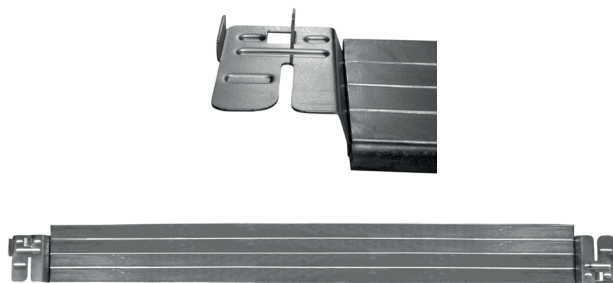
**Base Adjustment** / Pied Réglable / Base Regulable

Ø38x4 mm steel pipe, 150x150x5 mm base plate

Tube d'acier Ø38x4 mm, plaque de base galvanisée de 150x150x5 mm

Tubo de acero Ø38x4 mm, placa de base galvanizada de 150x150x5 mm

Code Code Código	Dimensions Dimensions Dimensiones	Weight Poids Peso	Price Prix Precio
PM-BA100	100 cm	4.1 kg	15,00 €
PM-BA070	70 cm	3.3 kg	13,50 €
PM-BA050	50 cm	2.8 kg	12,00 €

**Articulated Base Adjustment** / Pied Réglable Articulé / Base Regulable Articulada

Ø38x4 mm steel pipe, 150x150x5 mm base plate, galvanized

Tube d'acier Ø38x4 mm, plaque de base galvanisée de 150x150x5 mm

Tubo de acero Ø38x4 mm, placa de base galvanizada de 150x150x5 mm

Code Code Código	Dimensions Dimensions Dimensiones	Weight Poids Peso	Price Prix Precio
PM-ABA100	100 cm	4.6 kg	18,00 €
PM-ABA070	70 cm	3.8 kg	16,50 €
PM-ABA050	50 cm	3.3 kg	15,00 €

**Starting Member** / Pied de Départ / Pie de Arranque

Hot-dip galvanized

Galvanisé à chaud par immersion

Galvanizado por inmersión en caliente

Code Code Código	Dimensions Dimensions Dimensiones	Weight Poids Peso	Price Prix Precio
PM-SM	25 cm	1.6 kg	10,00 €



WALL CONNECTION KIT

Kit d'Amarrage Mural / Kit de Amarre Mural

Wall Connection Pipe / Tube d'Amarrage / Tubo de Amarre

Ø48x3.2 mm steel pipe, hot-dip galvanized

Tube d'acier Ø48x3.2 mm, galvanisé à chaud par immersion

Tubo de acero Ø48x3.2 mm, galvanizado por inmersión en caliente

Code Code Código	Dimensions Dimensions Dimensiones	Weight Poids Peso	Price Prix Precio
PM-CP100	100 cm	3.7 kg	12,00 €
PM-CP090	90 cm	3.3 kg	11,00 €
PM-CP080	80 cm	3.0 kg	10,00 €
PM-CP070	70 cm	2.8 kg	9,00 €
PM-CP060	60 cm	2.7 kg	8,00 €
PM-CP050	50 cm	1.9 kg	7,00 €
PM-CP040	40 cm	1.6 kg	6,00 €



Fixed Coupler / Collier Fixe / Abrazadera Fija

EN 74-1, forged, galvanized / EN 74-1, forgé, galvanisé / EN 74-1, forjado, galvanizado

Code Code Código	Dimensions Dimensions Dimensiones	Weight Poids Peso	Price Prix Precio
PM-FC	Ø48x48	1.0 kg	5,00 €



Wall Fixing Peg / Cheville / Perno

Code Code Código	Dimensions Dimensions Dimensiones	Weight Poids Peso	Price Prix Precio
PM-FP	M12	0.1 kg	0,50 €



Wall Fixing Bolt / Piton d'Amarrage / Pitón de Acero

Code Code Código	Dimensions Dimensions Dimensiones	Weight Poids Peso	Price Prix Precio
PM-FB	21,5 cm	0.2 kg	2,00 €



Swivel Coupler / Collier Orientable / Abrazadera Giratoria

EN 74-1, forged, galvanized / EN 74-1, forgé, galvanisé / EN 74-1, forjado, galvanizado

Code Code Código	Dimensions Dimensions Dimensiones	Weight Poids Peso	Price Prix Precio
PM-SC	Ø48x48	1.1 kg	5,50 €

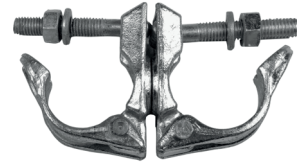
**Girder Coupler** / Collier de Poutre / Abrazadera para Viga

Forged, galvanized / Forgé, galvanisé / Forjado, galvanizado

Code Code Código	Dimensions Dimensions Dimensiones	Weight Poids Peso	Price Prix Precio
PM-GC	Ø48	1.4 kg	9,00 €

**Sleeve Coupler** / Manchon Tuyau Collier Double / Doble Abrazadera de Manga

Forged, galvanized / Forgé, galvanisé / Forjado, galvanizado

Code Code Código	Dimensions Dimensions Dimensiones	Weight Poids Peso	Price Prix Precio
PM-SVC	Ø48x48	1.0 kg	5,00 €

**Putlog Coupler** / Collier Putlog / Abrazadera Putlog

Forged, galvanized / Forgé, galvanisé / Forjado, galvanizado

Code Code Código	Dimensions Dimensions Dimensiones	Weight Poids Peso	Price Prix Precio
PM-PGC	Ø48	0.7 kg	4,00 €

**Pin Clamp** / Collier à Clavette / Abrazadera con Cuña

Forged, galvanized / Forgé, galvanisé / Forjado, galvanizado

Code Code Código	Dimensions Dimensions Dimensiones	Weight Poids Peso	Price Prix Precio
PM-PC	Ø48	0.7 kg	4,50 €



Rosette Clamp / Rosette Collier / Abrazadera Roseta

Forged, galvanized / Forgé, galvanisé / Forjado, galvanizado

Code Code Código	Dimensions Dimensions Dimensiones	Weight Poids Peso	Price Prix Precio
PM- RC	Ø125	1.2 kg	6,50 €



Fixing Pin / Goupille de Fixation / Pin de Fijación

Code Code Código	Dimensions Dimensions Dimensiones	Weight Poids Peso	Price Prix Precio
PM-FP	Ø10 mm	0.1 kg	1,00 €



Double Ledger End / Collier Double à Clavette / Abrazadera con Doble Cuñas

Code Code Código	Dimensions Dimensions Dimensiones	Weight Poids Peso	Price Prix Precio
PM-DLE	10 cm	1.1 kg	7,50 €



Pin Fixed Coupler / Collier Fixe à Clavette / Abrazadera de Cuña para Rodapiés

Forged, galvanized / Forgé, galvanisé / Forjado, galvanizado

Code Code Código	Dimensions Dimensions Dimensiones	Weight Poids Peso	Price Prix Precio
PM-PFC	Ø48 mm	1.1 kg	5,00 €



Pin Swivel Coupler / Collier Orientable à Clavette / Abrazadera Orientable de Cuña para Rodapiés

Forged, galvanized / Forgé, galvanisé / Forjado, galvanizado

Code Code Código	Dimensions Dimensions Dimensiones	Weight Poids Peso	Price Prix Precio
PM-PFC	Ø48 mm	1.1 kg	5,00 €

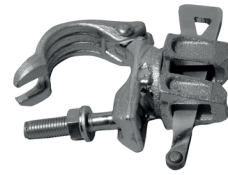
**Spigot Adapter Clamp** / Collier Adaptateur Spigot / Abrazadera Adaptadora de Espiga

Code Code Código	Dimensions Dimensions Dimensiones	Weight Poids Peso	Price Prix Precio
PM-SAC	Ø48	1.2 kg	5,50 €

**Base Adjustment Adapter Clamp** / Manchon Réglable à Collier / Abrazadera Adaptadora de Base Reglable

Code Code Código	Dimensions Dimensions Dimensiones	Weight Poids Peso	Price Prix Precio
PM-BAC	50 cm	2.4 kg	15,00 €

**Fixing Apparatus** / Appareil de Fixation / Aparato de Fijación

Code Code Código	Dimensions Dimensions Dimensiones	Weight Poids Peso	Price Prix Precio
PM-FA	75 cm	3.5 kg	15,00 €



Galvanized Pipe / Tube Galvanisé / Tubo Galvanizado

Ø48x3 mm steel pipe, hot-dip galvanized

Tube d'acier Ø48x3 mm, galvanisé à chaud par immersion

Tubo de acero Ø48x3 mm, galvanizado por inmersión en caliente

Code Code Código	Dimensions Dimensions Dimensiones	Weight Poids Peso	Price Prix Precio
PM-GP600	600 cm	21.0 kg	48,00 €
PM-GP300	300 cm	10.5 kg	24,00 €
PM-GP200	200 cm	7.0 kg	16,00 €
PM-GP100	100 cm	3.5 kg	8,00 €



Console / Console / Consola

Ø48x3 mm steel pipe, 40x40x2 mm profile, galvanized

Tube Ø48x3 mm, profilé de 40x40x2 mm, galvanisé

Tubo Ø48x3 mm, perfil de 40x40x2 mm, galvanizado

Code Code Código	Dimensions Dimensions Dimensiones	Weight Poids Peso	Price Prix Precio
PS-CON105	105 cm	11.0 kg	37,50 €
PS-CON075	75 cm	8.0 kg	32,50 €
PS-CON045	45 cm	4.5 kg	22,50 €



Steel Lattice Beam / Cadres de Liaison en Acier / Viga Enrejada de Acero

Ø48x3 mm steel pipe, hot-dip galvanized

Tube d'acier Ø48x3 mm, galvanisé à chaud par immersion

Tubo de acero Ø48x3 mm, galvanizado por inmersión en caliente

Code Code Código	Dimensions Dimensions Dimensiones	Weight Poids Peso	Price Prix Precio
PM-SLB820	45x820 cm	75.0 kg	260,00 €
PM-SLB720	45x720 cm	66.0 kg	235,00 €
PM-SLB620	45x620 cm	57.0 kg	210,00 €
PM-SLB520	45x520 cm	48.5 kg	185,00 €
PM-SLB420	45x420 cm	40.0 kg	160,00 €
PM-SLB320	45x320 cm	32.0 kg	135,00 €



Aluminium Lattice Beam / Cadres de Liaison en Aluminium / Viga Enrejada de Aluminio

Ø48x4 mm aluminium pipe

Tube d'aluminium Ø48x4 mm

Tubo de aluminio Ø48x4 mm

Code Code Código	Dimensions Dimensions Dimensiones	Weight Poids Peso	Price Prix Precio
PM-ALB820	45x820 cm	34.0 kg	465,00 €
PM-ALB720	45x720 cm	30.0 kg	415,00 €
PM-ALB620	45x620 cm	26.0 kg	365,00 €
PM-ALB520	45x520 cm	22.0 kg	315,00 €
PM-ALB420	45x420 cm	19.0 kg	265,00 €
PM-ALB320	45x320 cm	15.5 kg	215,00 €

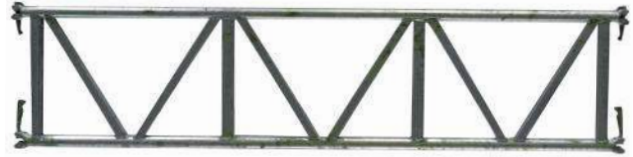
**Reinforced Horizontal Brace** / Longeron Renforcé / Barra Horizontal Reforzada

Ø48x2.5 mm pipe, hot-dip galvanized

Ø48x2.5 mm, galvanisé à chaud par immersion

Ø48x2.5 mm, galvanizado por inmersión en caliente

Code Code Código	Dimensions Dimensions Dimensiones	Weight Poids Peso	Price Prix Precio
PM-RHB300	30x300 cm	16.5 kg	63,40 €
PM-RHB250	30x250 cm	13.0 kg	56,80 €
PM-RHB200	30x200 cm	10.5 kg	50,00 €
PM-RHB140	30x140 cm	8.4 kg	43,40 €

**Container** / Conteneur / Contenedor

1.5 mm thickness, electrostatic painted

Épaisseur de 1.5 mm, peint électrostatique

Espesor de 1.5 mm, pintura electrostática

Code Code Código	Dimensions Dimensions Dimensiones	Weight Poids Peso	Price Prix Precio
PM-CNT	80x130 cm	60.0 kg	250,00 €



PreMulti Multidirectional Scaffolding Systems



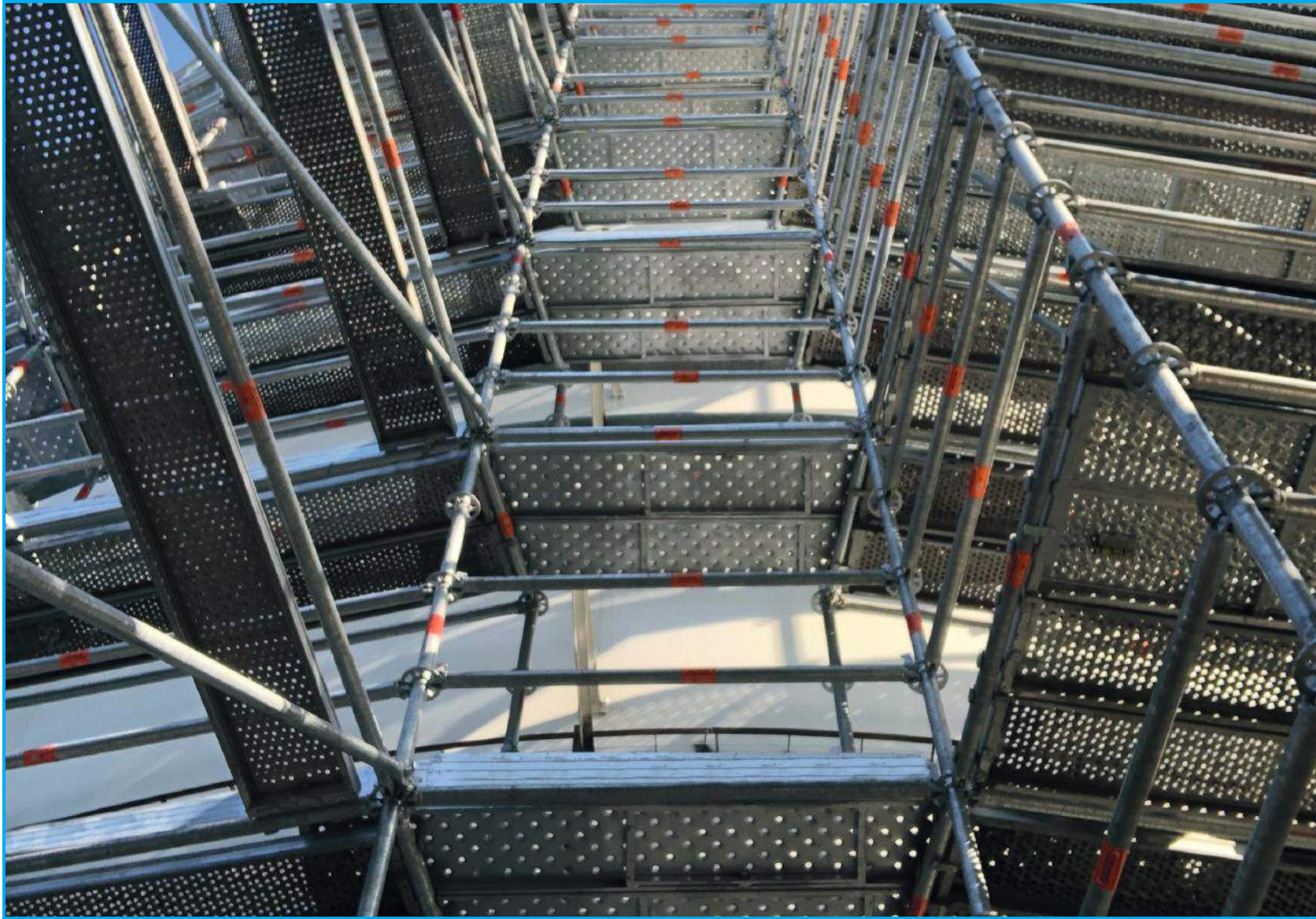

PreMobile

Mobile Scaffolding Systems

Systèmes d'Échafaudages Mobiles / Sistemas de Andamios Móviles

- 1- Mobile Scaffolding Chassis / Chassis d'Échafaudage Mobile / Chasis de Andamio Móvil
- 2- Galvanized Frame / Cadre Galvanisé / Cuadro Galvanizado
- 3- Console / Console / Consola
- 4- Base Adjustment / Pied Réglable / Base Regulable
- 5- Horizontal Brace / Barre Horizontale / Barra Horizontal
- 6- Diagonal Brace / Diagonale / Diagonal
- 7- Access Platform / Plate-forme avec Trappe d'Accès / Plataforma de Acceso
- 8- Steel Deck / Plate-forme en Acier / Plataforma de Acero
- 9- Steel End Toeboard / Plinthe Latérale / Rodapiés Lateral
- 10- Toeboard / Plinthe / Rodapiés

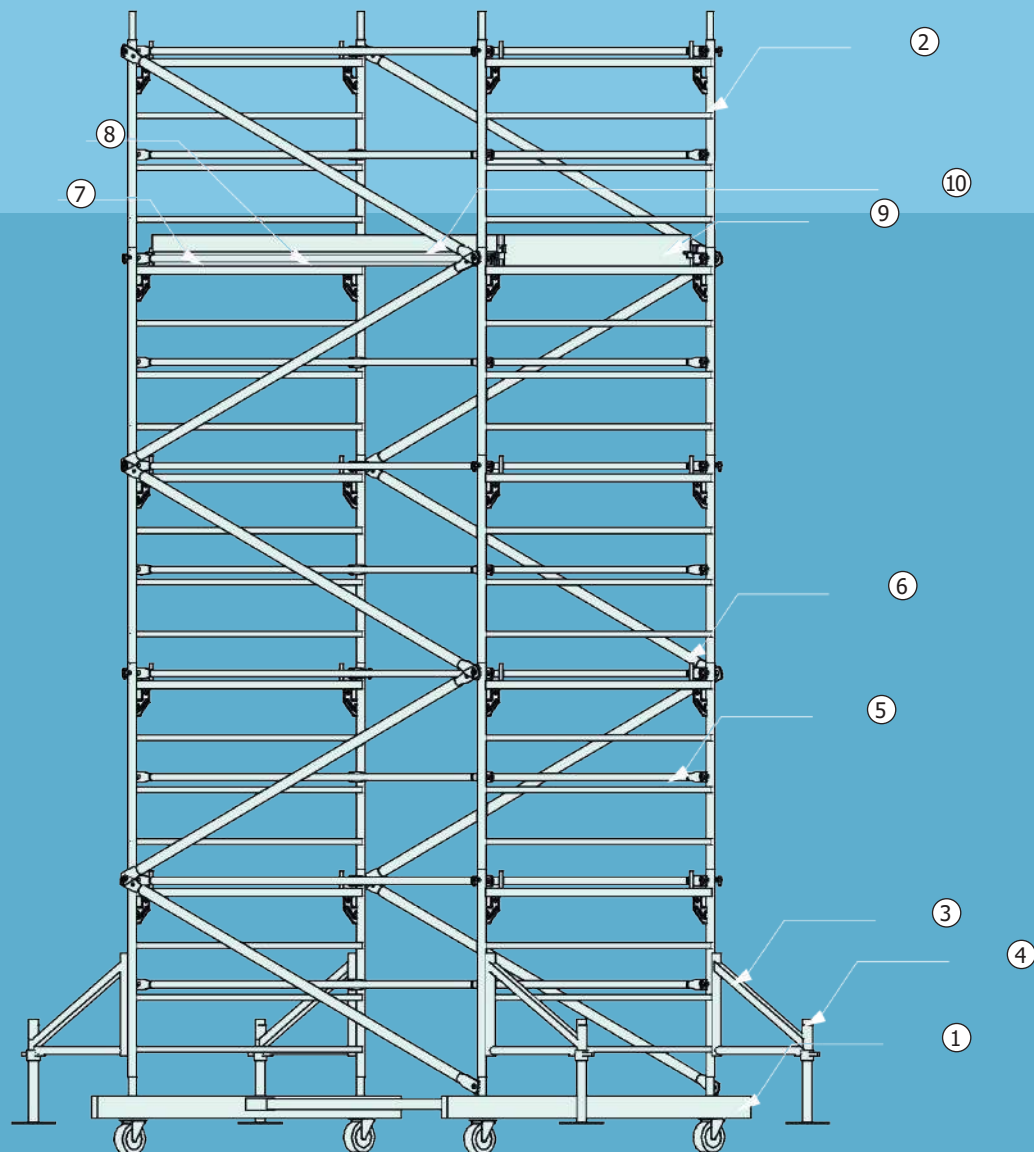

Galvanized Mobile Scaffolding System 150x250 cm

Système d'Échafaudage Mobile Galvanisé 150x250 cm



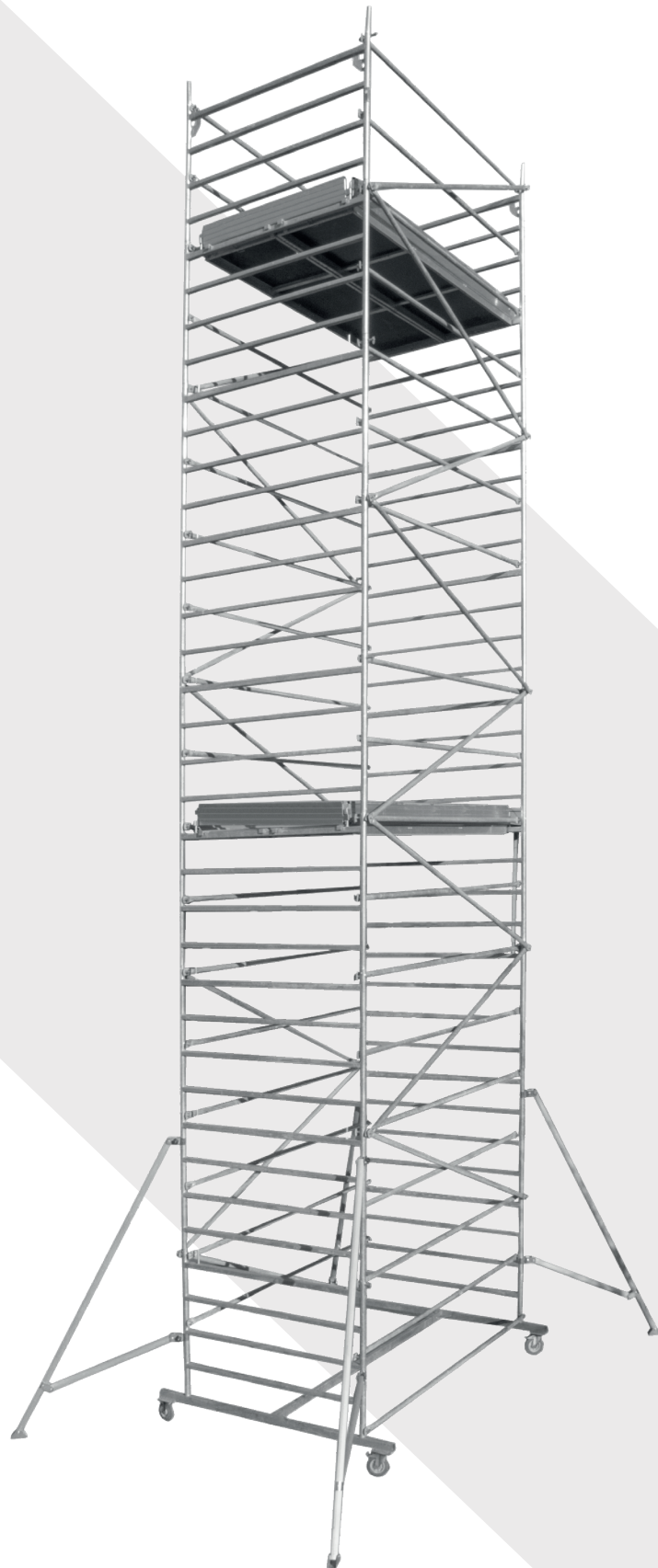





Sistema de Andamio Móvil Galvanizado 150x250 cm

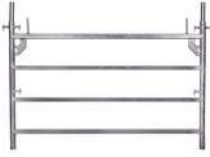

Galvanized Mobile Scaffolding System 150x250 cm

Système d'Échafaudage Mobile Galvanisé 150x250 cm









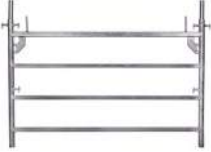

Sistema de Andamio Móvil Galvanizado 150x250 cm

Code Code Código	Material Description Description de Matériel Descripción de Material	Weight Poids Peso	Price Prix Precio	Height / Hauteur / Altura			
				4 m	6 m	8 m	
				Quantities Quantités / Cantidades			
PMB GF	Galvanized Mobile Scaffolding Frame 150x250 cm Cadre Galvanisé d'Échafaudage Mobile Cuadro Galvanizado para Andamio Móvil	18.2	60,00 €	6	10	14	
PMB CHS	Galvanized Mobile Scaffolding Chassis Chassis Galvanisé d'Échafaudage Mobile Chasis Galvanizado Andamio Móvil	46.0	140,00 €	1			
PMB HB250	Galvanized Horizontal Brace 250 cm Barre Horizontale Galvanisé Barra Horizontal Galvanizada	4.0	11,00 €	12	20	28	
PMB DB273	Galvanized Diagonal Brace 273 cm Diagonale Galvanisé Barra Diagonal Galvanizada	4.4	11,80 €	6	10	14	
PMB AD250	Aluminium Deck 63x250 cm Plate-forme en Aluminium Plataforma en Aluminio	17.5	160,00 €	1	1	2	
PMB AAP250	Aluminium Access Platform 63x250 cm Plate-forme d'Accès en Aluminium Plataforma de Acceso	18.5	190,00 €	1	1	2	
PMB WHL	Wheel 15 cm (with Brake) Roue 15 cm (avec Frein) Rueda 15 cm (con Freno)	6.5	60,00 €	4	4	4	
PMB ST200	Aluminium Stabilizer 200 cm Stabilisateur en Aluminium Estabilizador de Aluminio	5.0	60,00 €		4	4	
PMB T250	Galvanized Toeboard 250 cm Plinthe Galvanisé Rodapiés Galvanizado	5.0	16,00 €	2	2	4	
PMB T125	Galvanized Toeboard 125 cm Plinthe Galvanisé Rodapiés Galvanizado	2.7	11,00 €	2	2	4	
TOTAL PRICE / PRIX TOTAL / PRECIO TOTAL				1.346,80 €	1.822,00 €	2.601,20 €	
TOTAL WEIGHT / POIDS TOTAL / PESO TOTAL				307.0 kg	403.4 kg	577.2 kg	

Galvanized Mobile Scaffolding System 150x250 cm

Système d'Échafaudage Mobile Galvanisé 150x250 cm

Sistema de Andamio Móvil Galvanizado 150x250 cm

Code Code Código	Material Description Description de Matériel Descripción de Material	Weight Poids Peso	Price Prix Precio	Height / Hauteur / Altura			
				10 m	12 m	14 m	
				Quantities Quantités / Cantidades			
PMB GF	Galvanized Mobile Scaffolding Frame 150x250 cm Cadre Galvanisé d'Échafaudage Mobile Cuadro Galvanizado para Andamio Móvil	18.2	60,00 €	18	22	26	
PMB CHS	Galvanized Mobile Scaffolding Chassis Chassis Galvanisé d'Échafaudage Mobile Chasis Galvanizado Andamio Móvil	46.0	140,00 €	1	1	1	
PMB HB250	Galvanized Horizontal Brace 250 cm Barre Horizontale Galvanisé Barra Horizontal Galvanizada	4.0	11,00 €	36	44	52	
PMB DB273	Galvanized Diagonal Brace 273 cm Diagonale Galvanisé Barra Diagonal Galvanizada	4.4	11,80 €	18	22	26	
PMB AD250	Aluminium Deck 63x250 cm Plate-forme en Aluminium Plataforma en Aluminio	17.5	160,00 €	2	3	3	
PMB AAP250	Aluminium Access Platform 63x250 cm Plate-forme d'Accès en Aluminium Plataforma de Acceso	18.5	190,00 €	2	3	3	
PMB WHL	Wheel 15 cm (with Brake) Roue 15 cm (avec Frein) Rueda 15 cm (con Freno)	6.5	60,00 €	4	4	4	
PMB ST400	Aluminium Stabilizer 400 cm Stabilisateur en Aluminium Estabilizador de Aluminio	7.0	85,00 €	4			
PMB ST600	Aluminium Stabilizer 600 cm Stabilisateur en Aluminium Estabilizador de Aluminio	9.0	110,00 €		4	4	
PMB T250	Galvanized Toeboard 250 cm Plinthe Galvanisé Rodapiés Galvanizado	5.0	16,00 €	4	6	6	
PMB T125	Galvanized Toeboard 125 cm Plinthe Galvanisé Rodapiés Galvanizado	2.7	11,00 €	4	6	6	
TOTAL PRICE / PRIX TOTAL / PRECIO TOTAL				3.216,40 €	4.095,60 €	4.470,80 €	
TOTAL WEIGHT / POIDS TOTAL / PESO TOTAL				753.6 kg	935.4 kg	1.057.8 kg	

Aluminium Mobile Scaffolding System 140x250 cm











Système d'Échafaudage Mobile en Aluminium 140x250 cm

Sistema de Andamio Móvil de Aluminio 140x250 cm



Aluminium Mobile Scaffolding System 140x250 cm











Système d'Échafaudage Mobile en Aluminium 140x250 cm
Sistema de Andamio Móvil de Aluminio 140x250 cm

Code Code Código	Material Description Description de Matériel Descripción de Material	Weight Poids Peso	Price Prix Precio	Height Hauteur Altura			
				4 m	6 m	8 m	
				Quantities Quantités / Cantidades			
PMB AF200	Aluminium Mobile Scaffolding Frame 140x200 cm Cadre en Aluminium d'Échafaudage Mobile Cuadro de Aluminio para Andamio Móvil	14.3	200,00 €	2	4	6	
PMB AF115	Aluminium Mobile Scaffolding Frame 140x115 cm Cadre en Aluminium d'Échafaudage Mobile Cuadro de Aluminio De Andamio Móvil	7.0	90,00 €	2	2	2	
PMB AHB250	Aluminium Horizontal Brace 250 cm Barre Horizontale en Aluminium Barra Horizontal de Aluminio	2.5	30,00 €	2	2	2	
PMB ADB273	Aluminium Diagonal Brace 273 cm Diagonale en Aluminium Barra Diagonal de Aluminio	2.8	34,00 €	4	8	12	
PMB AHG	Aluminium H Guardrail 50x250 cm Garde-corps H en Aluminium Barandilla de Aluminio H	6.1	80,00 €	2	2	2	
PMB AD250	Aluminium Deck 63x250 cm Plate-forme en Aluminium Plataforma en Aluminio	17.5	160,00 €	1	1	2	
PMB AAP250	Aluminium Access Platform 63x250 cm Plate-forme d'Accès en Aluminium Plataforma de Acceso	18.5	190,00 €	1	1	2	
PMB WHL	Wheel 15 cm (with Brake) Roue 15 cm (avec Frein) Rueda 15 cm (con Freno)	6.5	60,00 €	4	4	4	
PMB ST200	Aluminium Stabilizer 200 cm Stabilisateur en Aluminium Estabilizador de Aluminio	5.0	60,00 €		4	4	
PMB T140	Toeboard Set 140x250 cm Set de Plinthe Kit de Rodapiés	14.0	75,00 €	1	1	1	
TOTAL PRICE / PRIX TOTAL / PRECIO TOTAL				1.601,00 € 2.377,00 € 3.263,00 €			
TOTAL WEIGHT / POIDS TOTAL / PESO TOTAL				147.0 kg 206.8 kg 282.6 kg			

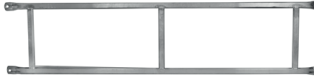
Aluminium Mobile Scaffolding System 140x250 cm

Système d'Échafaudage Mobile en Aluminium 140x250 cm

Sistema de Andamio Móvil de Aluminio 140x250 cm

Code Code Código	Material Description Description de Matériel Descripción de Material	Weight Poids Peso	Price Prix Precio	Height / Hauteur / Altura			
				10 m	12 m	14 m	
				Quantities Quantités / Cantidades			
PMB AF200	Aluminium Mobile Scaffolding Frame 140x200 cm Cadre en Aluminium d'Échafaudage Mobile Cuadro de Aluminio para Andamio Móvil	14.3	200,00 €	8	10	12	
PMB AF115	Aluminium Mobile Scaffolding Frame 140x115 cm Cadre en Aluminium d'Échafaudage Mobile Cuadro de Aluminio De Andamio Móvil	7.0	90,00 €	2	2	2	
PMB AHB250	Aluminium Horizontal Brace 250 cm Barre Horizontale en Aluminium Barra Horizontal de Aluminio	2.5	30,00 €	2	2	2	
PMB ADB273	Aluminium Diagonal Brace 273 cm Diagonale en Aluminium Barra Diagonal de Aluminio	2.8	34,00 €	16	20	24	
PMB AHG	Aluminium H Guardrail 50x250 cm Garde-corps H en Aluminium Barandilla de Aluminio H	6.1	80,00 €	2	2	2	
PMB AD250	Aluminium Deck 63x250 cm Plate-forme en Aluminium Plataforma en Aluminio	17.5	160,00 €	2	3	3	
PMB AAP250	Aluminium Access Platform 63x250 cm Plate-forme d'Accès en Aluminium Plataforma de Acceso	18.5	190,00 €	2	3	3	
PMB WHL	Wheel 15 cm (with Brake) Roue 15 cm (avec Frein) Rueda 15 cm (con Freno)	6.5	60,00 €	4	4	4	
PMB ST400	Aluminium Stabilizer 400 cm Stabilisateur en Aluminium Estabilizador de Aluminio	7.0	85,00 €	4			
PMB ST600	Aluminium Stabilizer 600 cm Stabilisateur en Aluminium Estabilizador de Aluminio	9.0	110,00 €		4	4	
PMB T140	Toeboard Set 140x250 cm Set de Plinthe Kit de Rodapiés	14.0	75,00 €	1	1	1	
TOTAL PRICE / PRIX TOTAL / PRECIO TOTAL				3.899,00 €	4.885,00 €	5.421,00 €	
TOTAL WEIGHT / POIDS TOTAL / PESO TOTAL				330.4 kg	414.2 kg	454.0 kg	

Aluminium Mobile Scaffolding System 75x250 cm

Système d'Échafaudage Mobile en Aluminium 75x250 cm









Sistema de Andamio Móvil de Aluminio 75x250 cm



Aluminium Mobile Scaffolding System 75x250 cm

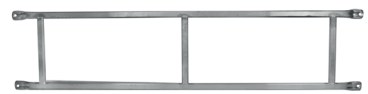







Système d'Échafaudage Mobile en Aluminium 75x250 cm

Sistema de Andamio Móvil de Aluminio 75x250 cm

Code Code Código	Material Description Description de Matériel Descripción de Material	Weight Poids Peso	Price Prix Precio	Height / Hauteur / Altura		
				4 m	6 m	
				Quantities Quantités / Cantidades		
PMB AF200	Aluminium Mobile Scaffolding Frame 75x200 cm Cadre en Aluminium d'Échafaudage Mobile Cuadro de Aluminio para Andamio Móvil	9.8	160,00 €	2	4	
PMB AF115	Aluminium Mobile Scaffolding Frame 75x115 cm Cadre en Aluminium d'Échafaudage Mobile Cuadro de Aluminio para Andamio Móvil	5.0	80,00 €	2	2	
PMB AHB200	Aluminium Horizontal Brace 250 cm Barre Horizontale en Aluminium Barra Horizontal de Aluminio	2.5	30,00 €	2	2	
PMB ADB227	Aluminium Diagonal Brace 273 cm Diagonale en Aluminium Barra Diagonal de Aluminio	2.8	34,00 €	4	8	
PMB AHG	Aluminium H Guardrail 50x250 cm Garde-Corps H en Aluminium Barandilla de Aluminio H	6.1	80,00 €	2	2	
PMB AAP200	Aluminium Access Platform 63x250 cm Plate-forme d'Accès en Aluminium Plataforma de Acceso	18.5	190,00 €	1	1	
PMB WHL	Wheel 15 cm (With Brake) Roue 15 cm (Avec Frein) Rueda 15 cm (Con Freno)	6.5	60,00 €	4	4	
PMB ST200	Aluminium Stabilizer 200 cm Stabilisateur en Aluminium Estabilizador de Aluminio	5.0	60,00 €		4	
PMB ST600	Toeboard Set 75x250 cm Set de Plinthe Kit de Rodapiés	11.5	65,00 €	1	1	
TOTAL PRICE / PRIX TOTAL / PRECIO TOTAL				1.331,00 €	2.027,00 €	
TOTAL WEIGHT / POIDS TOTAL / PESO TOTAL				114.0 kg	164.8 kg	

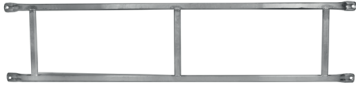
Aluminium Mobile Scaffolding System 75x250 cm

Système d'Échafaudage Mobile en Aluminium 75x250 cm
Sistema de Andamio Móvil de Aluminio 75x250 cm

Code Code Código	Material Description Description de Matériel Descripción de Material	Weight Poids Peso	Price Prix Precio	Height / Hauteur / Altura		
				8 m	10 m	
				Quantities Quantités / Cantidades		
PMB AF200	Aluminium Mobile Scaffolding Frame 75x200 cm Cadre en Aluminium d'Échafaudage Mobile Cuadro de Aluminio para Andamio Móvil	9.8	160,00 €	6	8	
PMB AF115	Aluminium Mobile Scaffolding Frame 75x115 cm Cadre en Aluminium d'Échafaudage Mobile Cuadro de Aluminio para Andamio Móvil	5.0	80,00 €	2	2	
PMB AHB200	Aluminium Horizontal Brace 250 cm Barre Horizontale en Aluminium Barra Horizontal de Aluminio	2.5	30,00 €	2	2	
PMB ADB227	Aluminium Diagonal Brace 273 cm Diagonale en Aluminium Barra Diagonal de Aluminio	2.8	34,00 €	12	16	
PMB AHG	Aluminium H Guardrail 50x250 cm Garde-Corps H en Aluminium Barandilla de Aluminio H	6.1	80,00 €	2	2	
PMB AAP200	Aluminium Access Platform 63x250 cm Plate-forme d'Accès en Aluminium Plataforma de Acceso	18.5	190,00 €	2	2	
PMB WHL	Wheel 15 cm (With Brake) Roue 15 cm (Avec Frein) Rueda 15 cm (Con Freno)	6.5	60,00 €	4	4	
PMB ST200	Aluminium Stabilizer 200 cm Stabilisateur en Aluminium Estabilizador de Aluminio	5.0	60,00 €	4		
PMB ST400	Aluminium Stabilizer 400 cm Stabilisateur en Aluminium Estabilizador de Aluminio	7.0	85,00 €		4	
PMB ST600	Toeboard Set 75x250 cm Set de Plinthe Kit de Rodapiés	11.5	65,00 €	1	1	
TOTAL PRICE / PRIX TOTAL / PRECIO TOTAL				2.673,00 €	3.229,00 €	
TOTAL WEIGHT / POIDS TOTAL / PESO TOTAL				214.1 kg	252.9 kg	

Aluminium Mobile Scaffolding System 75x150 cm







Système d'Échafaudage Mobile en Aluminium 75x150 cm

Sistema de Andamio Móvil de Aluminio 75x150 cm

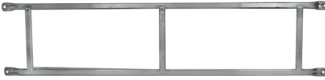

Aluminium Mobile Scaffolding System 75x150 cm

Système d'Échafaudage Mobile en Aluminium 75x150 cm
Sistema de Andamio Móvil de Aluminio 75x150 cm

Code Code Código	Material Description Description de Matériel Descripción de Material	Weight Poids Peso	Price Prix Precio	Height / Hauteur / Altura		
				4 m	6 m	
				Quantities Quantités / Cantidades		
PMB AF100	Aluminium Mobile Scaffolding Frame 75x100 cm Cadre en Aluminium d'Échafaudage Mobile Cuadro de Aluminio para Andamio Móvil	5.0	80,00 €	6	10	
PMB AHG	Aluminium H Guardrail 50x150 cm Garde-Corps H en Aluminium Barandilla de Aluminio H	4.6	80,00 €	5	8	
PMB AAP	Aluminium Access Platform 63x150 cm Plate-forme d'Accès en Aluminium Plataforma de Acceso	12.5	145,00 €	1	2	
PMB WHL	Wheel (With Brake) 15 cm Roue (Avec Frein) Rueda (Con Freno)	6.5	60,00 €	4	4	
PMB ST200	Aluminium Stabilizer 200 cm Stabilisateur en Aluminium Estabilizador de Aluminio	5.0	60,00 €		4	
PMB CR	Carrier Porteur Portador	0.9	5,00 €		4	
PMB LP	Locking Pin Pin de Verrouillage Pasador de Bloqueo	0.2	1,00 €	12	20	
PMB TSET	Toeboard Set 75x150 cm Set de Plinthe Kit de Rodapiés	8.0	55,00 €	1	1	
TOTAL PRICE / PRIX TOTAL / PRECIO TOTAL				1.332,00 €	2.305,00 €	
TOTAL WEIGHT / POIDS TOTAL / PESO TOTAL				101.9 kg	173.4 kg	

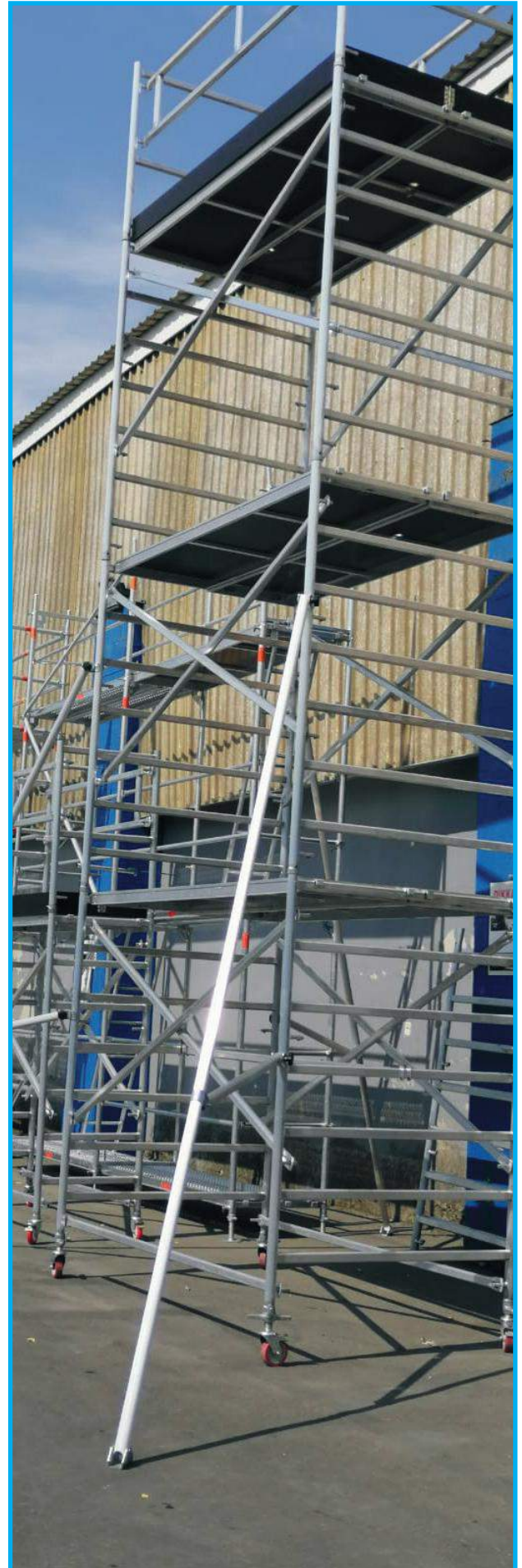

PreGuard

Edge Protection System

Barrière de Protection Anti-chute / Protección de Bordes

1- Post / Poste / Poste

2- Edge Protection Panel / Panel de Protection / Panel de Protección

3- Screw / Vis / Tornillo

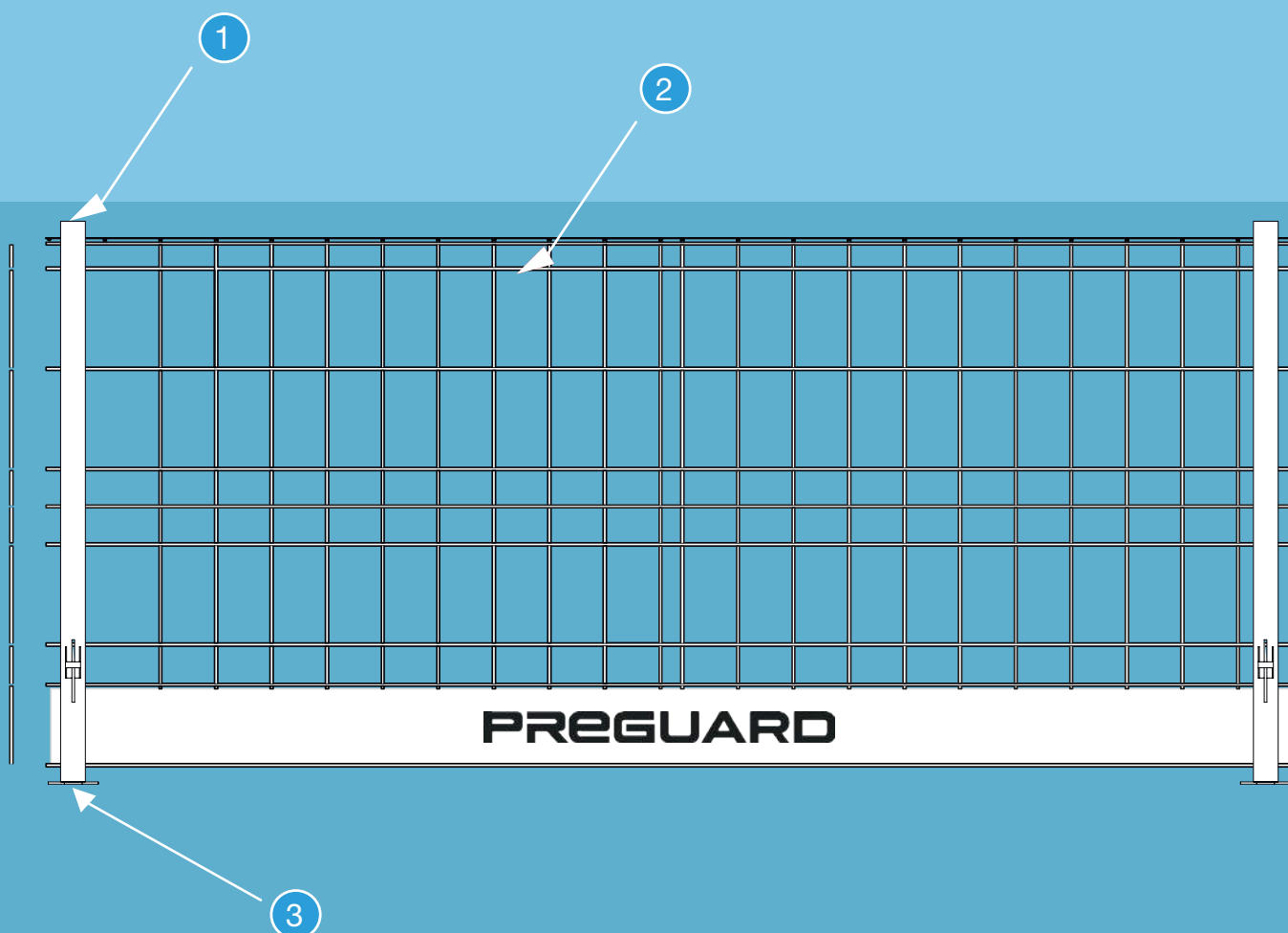

Edge Protection System (125 cm)

Système de Protection Anti-Chute / Sistema de Protección de Bordes

Code	Material Description	Dimensions	Weight	Price	Quantities
Code	Description de Matériel	Dimensions	Poids	Prix	Quantités
Código	Descripción de Material	Dimensiones	Peso	Precio	Cantidades

PG P112	Post / Poste / Poste 30x50x2 mm profile, galvanized Profilé de 30x50x2 mm, galvanisé Perfil de 30x50x2 mm, galvanizado	112 cm	3.2	15,00 €	2	
PG PNL125	Edge Protection Panel Panel de Protection Panel de Protección Ø6 wire, 15 cm toeboard, oven painted (RAL 1003) Ø6 fil de fer, plinthe de 15 cm, peinture au four (RAL 1003) Ø6 alambre, rodapiés de 15 cm, pintada al horno (RAL 1003)	125 cm	7.5	25,00 €	1	
PG SCR	Screw / Vis / Tornillo Galvanized / Galvanisé / Galvanizado	M10x70 cm	0.1	1,25 €	4	
TOTAL PRICE / PRIX TOTAL / PRECIO TOTAL				60,00 €		
TOTAL WEIGHT / POIDS TOTAL / PESO TOTAL				14.3 kg		

Edge Protection System (250 cm)

Système de Protection Anti-Chute / Sistema de Protección de Bordes

Code	Material Description	Dimensions	Weight	Price	Quantities
Code	Description de Matériel	Dimensions	Poids	Prix	Quantités
Código	Descripción de Material	Dimensiones	Peso	Precio	Cantidades

PG P112	Post / Poste / Poste 30x50x2 mm profile, galvanized Profilé de 30x50x2 mm, galvanisé Perfil de 30x50x2 mm, galvanizado	112 cm	3.2	15,00 €	2	
PG PNL250	Edge Protection Panel Panel de Protection Panel de Protección Ø6 wire, 15 cm toeboard, oven painted (RAL 1003) Ø6 fil de fer, plinthe de 15 cm, peinture au four (RAL 1003) Ø6 alambre, rodapiés de 15 cm, pintada al horno (RAL 1003)	250 cm	15.0	42,00 €	1	
PG SCR	Screw / Vis / Tornillo Galvanized / Galvanisé / Galvanizado	M10x70 cm	0.1	1,25 €	4	
TOTAL PRICE / PRIX TOTAL / PRECIO TOTAL				77,00 €		
TOTAL WEIGHT / POIDS TOTAL / PESO TOTAL				21.8 kg		

Beam Compressible Post / Poste à Poutre Compressible / Poste Compresible por Vigas

40x40x1 mm - 35x35x1.5 mm profile, galvanized

Profilé de 40x40x1 mm – 35x35x1.5 mm, galvanisé

Perfil de 40x40x1 mm – 35x35x1.5 mm, galvanizado

Code Code Código	Dimensions Dimensions Dimensiones	Weight Poids Peso	Price Prix Precio
PG-BCP	125-175 cm	6.8 kg	40,00 €

**Wood Compressible Post** / Poste à Bois Compressible / Poste Compresible por Madera

40x40x1 mm - 35x35x1.5 mm profile, galvanized

Profilé de 40x40x1 mm – 35x35x1.5 mm, galvanisé

Perfil de 40x40x1 mm – 35x35x1.5 mm, galvanizado

Code Code Código	Dimensions Dimensions Dimensiones	Weight Poids Peso	Price Prix Precio
PG-WCP	125-200 cm	6.5 kg	35,00 €

**Distance Adjusted Post** / Poste à Distance Ajustable / Poste con Distancia Ajustable

40x40x1 mm - 35x35x1.5 mm profile, galvanized

Profilé de 40x40x1 mm – 35x35x1.5 mm, galvanisé

Perfil de 40x40x1 mm – 35x35x1.5 mm, galvanizado

Code Code Código	Dimensions Dimensions Dimensiones	Weight Poids Peso	Price Prix Precio
PG-DAP	40 cm	3.5 kg	30,00 €



Pin Post / Poste à Clavette / Poste de Cuña

30x50x2 mm, galvanized

30x50x2 mm, galvanisé

30x50x2 mm, galvanizado

Code Code Código	Dimensions Dimensions Dimensiones	Weight Poids Peso	Price Prix Precio
PG-PIN	112 cm	3.2 kg	15,00 €



L Post / Poste L / Poste L

30x50x2 mm, galvanized

30x50x2 mm, galvanisé

30x50x2 mm, galvanizado

Code Code Código	Dimensions Dimensions Dimensiones	Weight Poids Peso	Price Prix Precio
PG-LP	120 cm	3.4 kg	20,00 €



Pin L / L Poste à Clavette / L Poste de Cuña

30x50x2 mm, galvanized

30x50x2 mm, galvanisé

30x50x2 mm, galvanizado

Code Code Código	Dimensions Dimensions Dimensiones	Weight Poids Peso	Price Prix Precio
PG-LPP	120 cm	3.4 kg	22,00 €



Wall Bracket / Crochet Mural / Soporte Mural

Galvanized / Galvanisé / Galvanizado

Code Code Código	Dimensions Dimensions Dimensiones	Weight Poids Peso	Price Prix Precio
PG-WB	15 cm	0.2 kg	4,00 €



Adjustable Horizontal Brace / Barre Horizontale Réglable / Barra Horizontal Regulable

Ø42x2 mm - 34x2 mm, galvanized

Ø42x2 mm - 34x2 mm, galvanisé
Ø42x2 mm - 34x2 mm, galvanizado

Code Code Código	Dimensions Dimensions Dimensiones	Weight Poids Peso	Price Prix Precio
PG-AHB-350	200-350 cm	6.8 kg	20,00 €
PG-AHB-270	155-270 cm	6.0 kg	18,00 €
PG-AHB-120	80-120 cm	3.0 kg	12,00 €



Stair Bracket / Crochet d'Échelle / Soporte para Escaleras

Galvanized / Galvanisé / Galvanizado

Code Code Código	Dimensions Dimensions Dimensiones	Weight Poids Peso	Price Prix Precio
PG-SB	20 cm	0.3 kg	5,00 €

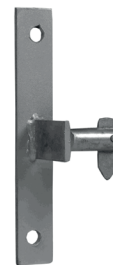

Ground Support Plate / Plaque d'Appui / Placa de Apoyo

Galvanized / Galvanisé / Galvanizado

Code Code Código	Dimensions Dimensions Dimensiones	Weight Poids Peso	Price Prix Precio
PG-GSP	30x90 cm	2.8 kg	20,00 €

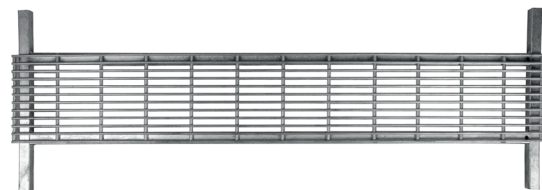

Panel Stacking Frame / Cadre d'Empilage de Panneaux / Marco de Apilamiento de Paneles

Code Code Código	Dimensions Dimensions Dimensiones	Weight Poids Peso	Price Prix Precio
PG-PSF	80x140 cm	29.0 kg	100,00 €



Security Barrier / Barrière de Sécurité / Valla de Seguridad

Code Code Código	Dimensions Dimensions Dimensiones	Weight Poids Peso	Price Prix Precio
PG-SB	110x200 cm	15 kg	75,00 €



Plywood / Contreplaqué / Madera Contrachapada

Pine / Pin / Pino

Dimensions Dimensions Dimensiones	Thickness Épaisseur Espesor	Price Prix Precio
1250x2500 mm	18 mm	65,00 €

9 layer tree + 2 layer film / 9 couches arbre + 2 couches film / 9 capas de árbol + 2 capas de cinta

1250x2500 mm	21 mm	75,00 €
--------------	-------	---------

11 layer tree + 2 layer film / 11 couches arbre + 2 couches film / 11 capas de árbol + 2 capas de cinta

Pine & Poplar / Pin & Peuplier / Pino & Álamo

Dimensions Dimensions Dimensiones	Thickness Épaisseur Espesor	Price Prix Precio
1250x2500 mm	18 mm	60,00 €

9 layer tree + 2 layer film / 9 couches arbre + 2 couches film / 9 capas de árbol + 2 capas de cinta

1250x2500 mm	21 mm	70,00 €
--------------	-------	---------

11 layer tree + 2 layer film / 11 couches arbre + 2 couches film / 11 capas de árbol + 2 capas de cinta

Birch / Bouleau / Abedul

Dimensions Dimensions Dimensiones	Thickness Épaisseur Espesor	Price Prix Precio
1250x2500 mm	18 mm	86,00 €

Filmed birch 13 layer / Bouleau filmé 13 couches / Abedul filmado 13 capas





PreCont Modular Systems

Systèmes Modulaires / Sistemas Modulares

- 1- Lower Chassis / Chassis Inférieur / Chasis Inferior
- 2- Upper Chassis / Chassis Supérieur / Chasis Superior
- 3- Lower Structure / Structure Inférieur / Estructura Inferior
- 4- Upper Structure / Structure Supérieur / Estructura Superior
- 5- Corner Posts / Poteaux de Coin / Postes de Esquinas
- 6- Exterior Walls / Murs Extérieurs / Paredes Exteriores
- 7- Interior Walls / Murs Intérieurs / Paredes Interiores
- 8- Ceiling Coating / Couverture de Plafond / Cubierta de Techo Interior
- 9- Floor Decking / Couverture de Sol / Cubierta de Suelo
- 10- Roof Insulation / Isolation de Toit / Aislamiento de Techo
- 11- Roof Covering / Couverture de Toit / Cubierta de Techo Exterior
- 12- Floor Covering / Revêtement de Sol / Revestimiento de Suelo
- 13- Interior Doors / Portes Intérieures / Puertas Interiores
- 14- Windows / Fenêtres / Ventanas
- 15- Exterior Doors / Portes Extérieures / Puertas Exteriores
- 16- Vasistas Windows / Vasistas / Vasistas



PRECONT - S

Single Room Container
 Conteneur Une Chambre
 Contenedor Un Cuarto

Dimensions Dimensions / Dimensiones	Price Prix / Precio
2.40x6.00 m	4.400,00 €
3.00x7.00 m	5.200,00 €

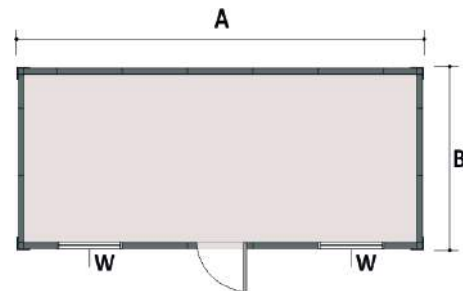
**PRECONT - SB**

Single Room Container with Sanitary
 Conteneur Une Chambre avec Sanitaire
 Contenedor Un Cuarto con Sanitario

Dimensions Dimensions / Dimensiones	Price Prix / Precio
2.40x6.00 m	5.400,00 €
3.00x7.00 m	6.450,00 €

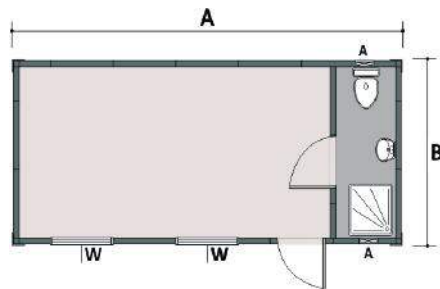
**PRECONT - SBE**

Single Room Container with Sanitary & Kitchen Sink
 Conteneur Une Chambre avec Sanitaire & Évier
 Contenedor Un Cuarto con Sanitario y Fregadero

Dimensions Dimensions / Dimensiones	Price Prix / Precio
2.40x6.00 m	5.700,00 €
3.00x7.00 m	6.750,00 €

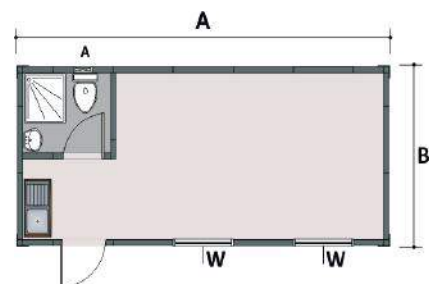

PRECONT - SE

Single Room Container with Kitchen Sink

Conteneur Une Chambre avec Évier

Contenedor Un Cuarto con Fregadero

Dimensions Dimensions / Dimensiones	Price Prix / Precio
2.40x6.00 m	4.700,00 €
3.00x7.00 m	5.500,00 €

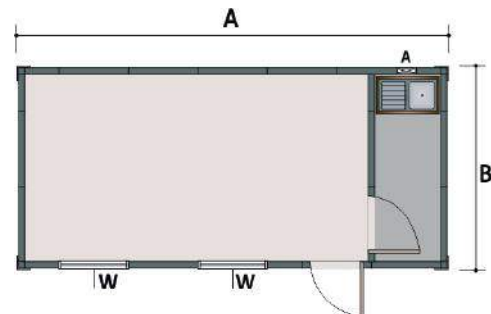

PRECONT - SWC

Single Room Container with WC

Conteneur Une Chambre avec Toilette

Contenedor Un Cuarto con Aseos

Dimensions Dimensions / Dimensiones	Price Prix / Precio
2.40x6.00 m	5.300,00 €
3.00x7.00 m	6.350,00 €

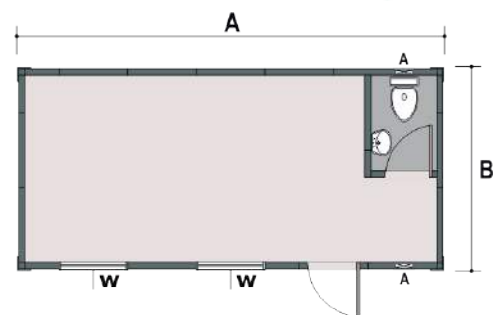

PRECONT - SWCE

Single Room Container with WC & Kitchen Sink

Conteneur Une Chambre avec Toilette & Évier

Contenedor Un Cuarto con Aseos & Fregadero

Dimensions Dimensions / Dimensiones	Price Prix / Precio
2.40x6.00 m	5.600,00 €
3.00x7.00 m	6.650,00 €

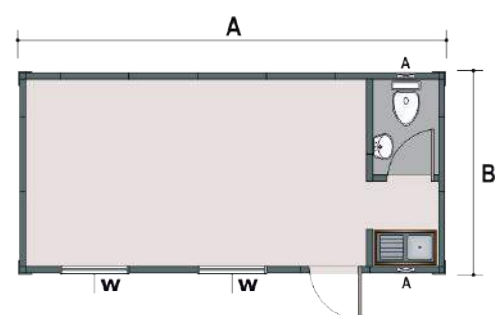

PRECONT - 2S

Double Room Container
 Conteneur Double Chambres
 Contenedor Doble Cuartos

Dimensions Dimensions / Dimensiones	Price Prix / Precio
2.40x6.00 m	4.600,00 €
3.00x7.00 m	5.400,00 €

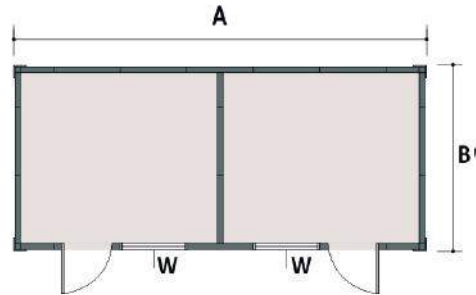

PRECONT - 2SB

Double Room Container with Sanitary
 Conteneur Double Chambres avec Sanitaire
 Contenedor Doble Cuartos con Sanitario

Dimensions Dimensions / Dimensiones	Price Prix / Precio
2.40x6.00 m	5.850,00 €
3.00x7.00 m	6.950,00 €

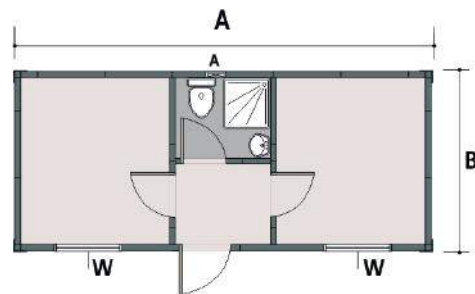

PRECONT - 2SBE

Double Room Container with Sanitary & Kitchen Sink
 Conteneur Double Chambres avec Sanitaire & Évier
 Contenedor Doble Cuartos con Sanitario y Fregadero

Dimensions Dimensions / Dimensiones	Price Prix / Precio
2.40x6.00 m	6.150,00 €
3.00x7.00 m	7.100,00 €

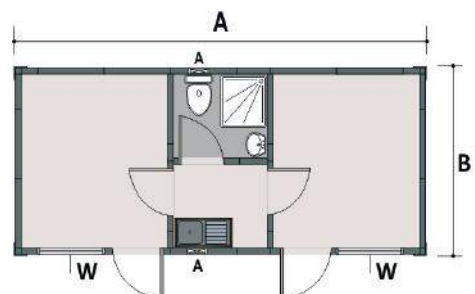

PRECONT - 2SE

Double Room Container with Kitchen Sink
 Conteneur Double Chambres avec Évier
 Contenedor Doble Cuartos con Fregadero

Dimensions Dimensions / Dimensiones	Price Prix / Precio
2.40x6.00 m	5.200,00 €
3.00x7.00 m	6.100,00 €

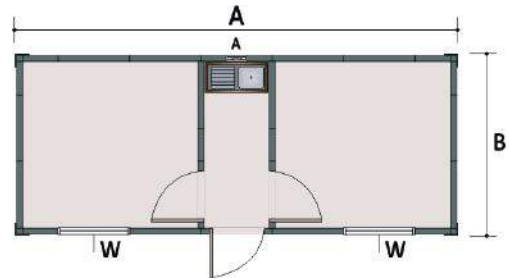

PRECONT - 2SWC

Double Room Container with WC
 Conteneur Double Chambres avec Toilette
 Contenedor Doble Cuartos con Aseos

Dimensions Dimensions / Dimensiones	Price Prix / Precio
2.40x6.00 m	5.460,00 €
3.00x7.00 m	6.500,00 €

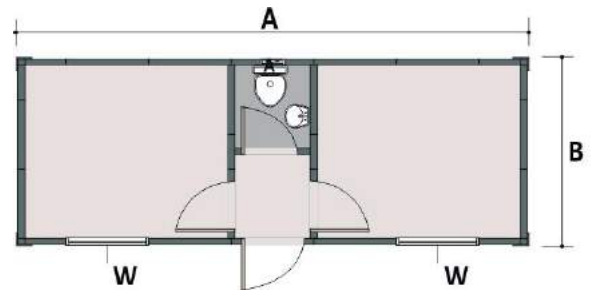

PRECONT - 2SWCE

Double Room Container with WC & Kitchen Sink
 Conteneur Double Chambres avec Toilette & Evier
 Contenedor Doble Cuartos con Aseos y Fregaderos

Dimensions Dimensions / Dimensiones	Price Prix / Precio
2.40x6.00 m	5.800,00 €
3.00x7.00 m	6.900,00 €

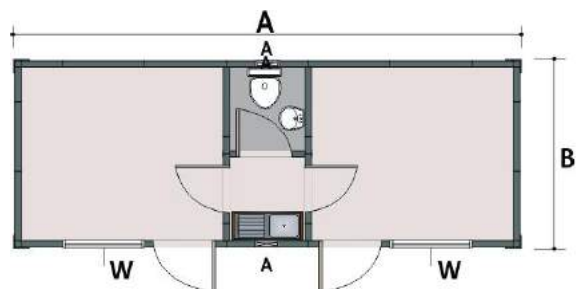

PRECONT - WC1

Single Toilet Container
 Conteneur à Une Toilette
 Contenedor Sólo Aseos

Dimensions Dimensions / Dimensiones	Price Prix / Precio
1.50x1.50 m	2.650,00 €

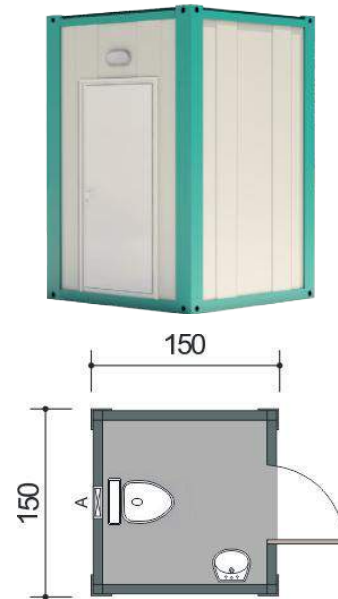

PRECONT - DWC2

Sanitary Container with 2 Toilets & 1 Shower
 Conteneur Sanitaire 2 Toilettes & 1 Douche
 Contenedor Sanitario con 2 Aseos & 1 Ducha

Dimensions Dimensions / Dimensiones	Price Prix / Precio
2.40x3.00 m	4.900,00 €

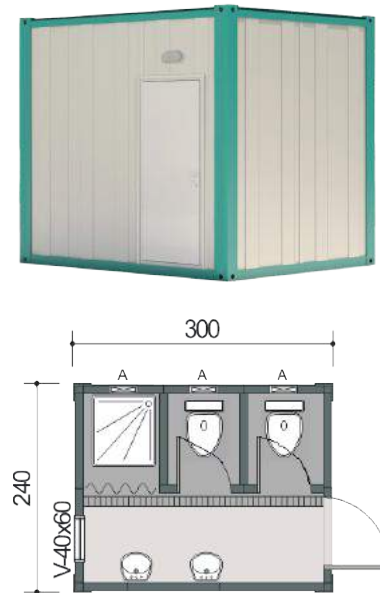

PRECONT - D2WC2

Sanitary Container with 2 Toilets & 2 Showers
 Conteneur Sanitaire 2 Toilettes & 2 Douches
 Contenedor Sanitario con 2 Aseos & 2 Duchas

Dimensions Dimensions / Dimensiones	Price Prix / Precio
2.40x4.00 m	6.400,00 €

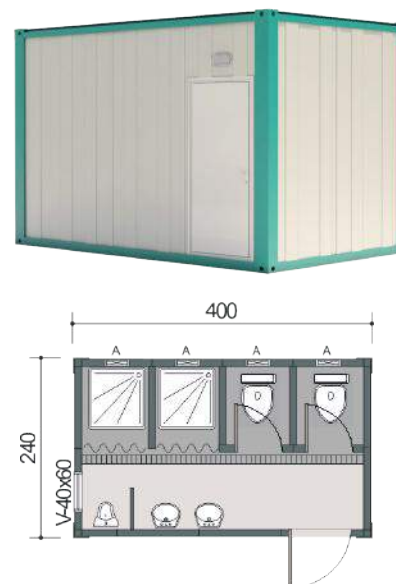

PRECONT - WC6

Sanitary Container with 6 Toilets
 Conteneur Sanitaire 6 Toilettes
 Contenedor Sanitario con 6 Aseos

Dimensions Dimensions / Dimensiones	Price Prix / Precio
2.40x6.00 m	9.400,00 €

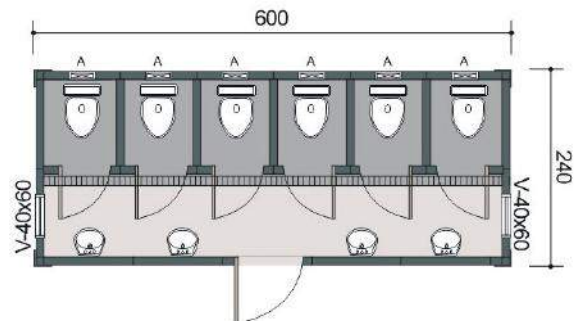

PRECONT - D6

Sanitary Container with 6 Showers
 Conteneur Sanitaire 6 Douches
 Contenedor Sanitario con 6 Duchas

Dimensions Dimensions / Dimensiones	Price Prix / Precio
2.40x6.00 m	8.900,00 €

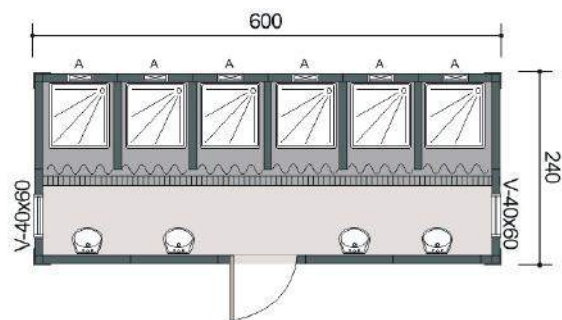

PRECONT - D3WC3

Sanitary Container with 3 Toilets & 3 Showers
 Conteneur Sanitaire 3 Toilettes & 3 Douches
 Contenedor Sanitario con 3 Aseos & 3 Duchas

Dimensions Dimensions / Dimensiones	Price Prix / Precio
2.40x6.00 m	9.000,00 €

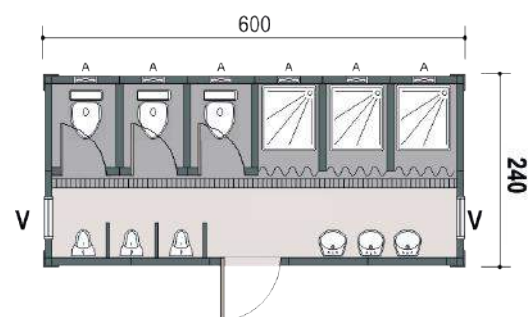

PRECAB 1

Dimensions Dimensions / Dimensiones	Price Prix / Precio
1.25x1.25 m	1.400,00 €

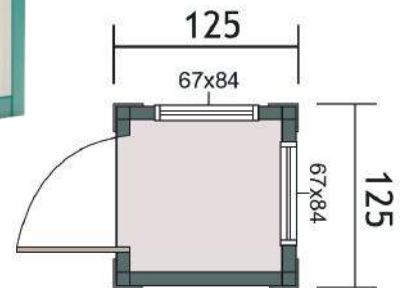
**PRECAB 2**

Dimensions Dimensions / Dimensiones	Price Prix / Precio
1.25x1.50 m	1.500,00 €

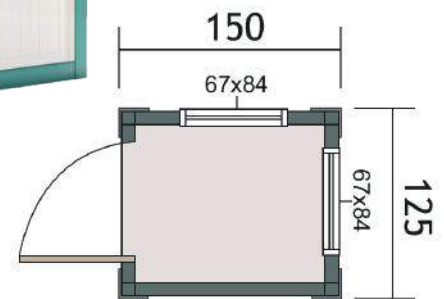
**PRECAB 3**

Dimensions Dimensions / Dimensiones	Price Prix / Precio
1.25x2.00 m	1.850,00 €

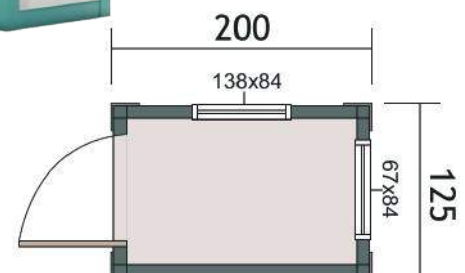

PREPOLY WC

Dimensions
Dimensions / Dimensiones

1.10x1.10x2.35 m

Price
Prix / Precio

1.750,00 €



PREPOLY D

Dimensions
Dimensions / Dimensiones

1.10x1.10x2.35 m

Price
Prix / Precio

1.650,00 €







Flatpack Container

